



GUI SOFTWARE

# USER MANUAL

[WWW.UNICORE.COM](http://WWW.UNICORE.COM)

# UPrecise Software

Copyright© 2009-2025, Unicore Communications, Inc.  
Data subject to change without notice.



# Revision History

Version	Changes	Date
R1.0	First release	Sep., 2022
R1.1	<ul style="list-style-type: none"><li>• Support seven satellite systems</li><li>• Add 2.2.12 Tools</li></ul>	Mar., 2023
R2.0	<ul style="list-style-type: none"><li>• Update receiver connection limit</li><li>• Update sections 2.3.3, 2.3.4, 2.3.5, 2.3.8 (message enablement)</li><li>• Update section 2.3.12 Tools</li></ul>	Jan., 2024
R2.1	<ul style="list-style-type: none"><li>• Added description about the Multi-Channel option in <a href="#">Map</a></li><li>• Added description about IC-to-Cloud in <a href="#">RTCM Monitor</a></li><li>• Added the following chapters:<ul style="list-style-type: none"><li>- <a href="#">KMZ</a></li><li>- <a href="#">Converter</a></li><li>- <a href="#">NtripCaster</a></li></ul></li><li>• Added that NMEA h30 is not supported in <a href="#">Message</a></li><li>• Added that UM68X series is not supported in <a href="#">Receiver Upgrade</a></li><li>• Added how to upgrade receivers with config.init file</li><li>• Removed the <b>Operation Logging</b> in <a href="#">Platform Checking</a> check box</li><li>• Update frequency colors</li></ul>	Aug., 2024
R2.2	<ul style="list-style-type: none"><li>• Added the following sections:<ul style="list-style-type: none"><li>- <a href="#">Manually Add Product Models</a></li><li>- <a href="#">Data</a></li></ul></li><li>• Changed interface layout of multiple sections<ul style="list-style-type: none"><li>- <a href="#">RTCM Monitor</a></li><li>- <a href="#">Interference Detection</a></li></ul></li><li>• Changed the contact email to <a href="mailto:info@unicorecomm.com">info@unicorecomm.com</a></li><li>• Added an example about converting data to Rinex format in <a href="#">Converter</a></li><li>• Added description about the configuration items in <a href="#">TTFF</a></li></ul>	July, 2025

## Legal Right Notice

This manual provides information and details on the products of Unicore Communication, Inc. ("Unicore") referred to herein.



All rights, title and interest to this document and the information such as data, designs, layouts contained in this manual are fully reserved, including but not limited to the copyrights, patents, trademarks and other proprietary rights as relevant governing laws may grant, and such rights may evolve and be approved, registered or granted from the whole information aforesaid or any part(s) of it or any combination of those parts.

Unicore holds the trademarks of “和芯星通”, “Unicore”, “UNICORECOMM” and other trade name, trademark, icon, logo, brand name and/or service mark of Unicore products or their product serial referred to in this manual (collectively “Unicore Trademarks”).

This manual or any part of it, shall not be deemed as, either expressly, implied, by estoppel or any other form, the granting or transferring of Unicore rights and/or interests (including but not limited to the aforementioned trademark rights), in whole or in part.

### **Disclaimer**

The information contained in this manual is provided “as is” and is believed to be true and correct at the time of its publication or revision. This manual does not represent, and in any case, shall not be construed as a commitments or warranty on the part of Unicore with respect to the fitness for a particular purpose/use, the accuracy, reliability and correctness of the information contained herein.

Information, such as product specifications, descriptions, features and user guide in this manual, are subject to change by Unicore at any time without prior notice, which may not be completely consistent with such information of the specific product you purchase.

Should you purchase our product and encounter any inconsistency, please contact us or our local authorized distributor for the most up-to-date version of this manual along with any addenda or corrigenda.



# Foreword

---

This document gives an introduction of the software UPrecise, including the operations and UI descriptions, etc.

## **Target Readers**

This document applies to users or manufactures/companies that use the products from Unicore.



# 1 UPrecise Introduction

## 1.1 Description of UPrecise

---

UPrecise is a GNSS evaluation software developed by Unicore. It aims to help you conveniently do operations on the receivers with graphical real-time monitoring and playback function.

Using this software, you can interact with receivers by serial ports or TCP/IP and see the status information. After connecting the receivers, UPrecise can automatically identify the baud rates and type of the receivers, and display the specific message configurations and parsed sentences.

## 1.2 Functions

---

See the table [Feature](#) for the information about UPrecise features.

Table1-1 Feature

Features	Description
Data Stream	displays the raw data in real time or playback, and provides a command input box for real-time interaction with the receivers.
Constellations	displays a general distribution of the visible satellites in real time or playback.
Tracking Status	displays the change of C/N0 and tracking status in real time or playback, which varies according to the window size (normal size or maximized size).
Map	shows the positioning information including the positioning point and the trajectory drawn in real time or playback on the loaded map in the language you select (Google Maps or Baidu Maps). The function is particularly suitable for viewing the trajectory of the running cars.
Message	dynamically displays the parsed NMEA and other messages according to the type of the receivers.



Features	Description
<b>Discrete Trajectory</b>	shows the longitude and latitude of the positioning point, as well as the horizontal discrete degree in real time or playback. When receiving static signals, it enables you to view the degree in different scales.
<b>Attitude</b>	displays the information of positioning and attitude, which enables you to know the receivers' attitude intuitively.
<b>Receiver Configuration</b>	supports to query and configure the parameters of the receiver according to its type, so that you can interact with the receiver more conveniently.
<b>Data</b>	shows the location information, such as latitude, longitude, altitude, etc.
<b>Replay</b>	UPrecise uses the saved data to show the parsed messages and draw visual graphics. Except the data saving and command interaction, other functions can work as same as those in real time.
<b>Receiver Upgrade</b>	supports the firmware upgrade of the receivers from Unicore.
<b>Tools</b>	including: Interference Detection (CWOUT), RTCM Monitor, KMZ, Converter, TTFE, NtripCaster.



## 1.3 Install UPrecise

---

See the table [UPrecise Version Information](#) for the systems that are compatible with UPrecise.

Two options are supported to install UPrecise:

- Use installation package. This can prevent file corruption during the process.
- Use the green package. The corresponding DLL, EXE, and LIB files are required (all files must be located in the same folder).

**Tip:**

If UPrecise is identified as suspicious by antivirus software, choose to trust.

Table1-2 UPrecise Version Information

Name	Language	OS (64 bits)
UPrecise	Chinese/English	Windows 7/Windows 8/Windows 10

The following describes the installation procedure for the Chinese version of UPrecise using the executable installation package:

1. Double-click the installer executable, choose the interface language from the dropdown menu, and proceed by clicking the Next button.
2. Open UPrecise after installation. See [UPrecise Primary Layout](#) for the main interface.

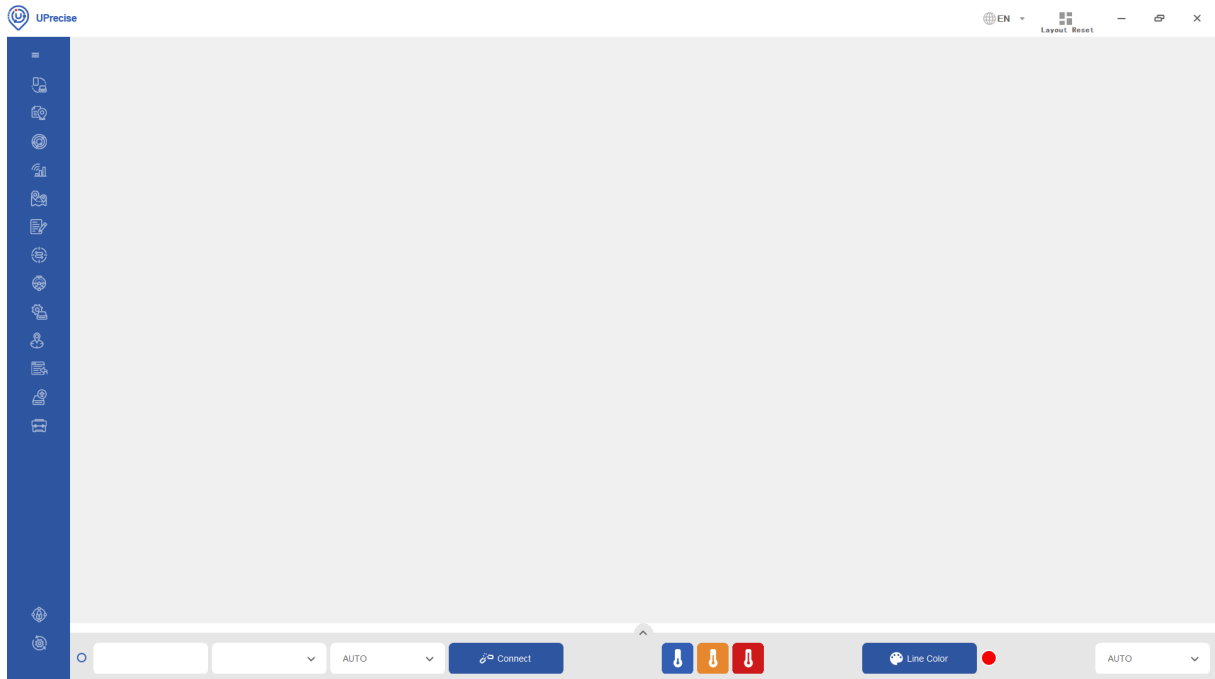

Figure1-1 UPrecise Primary Layout

## 2 UPrecise Interface

The primary layout of UPrecise is divided into four areas.

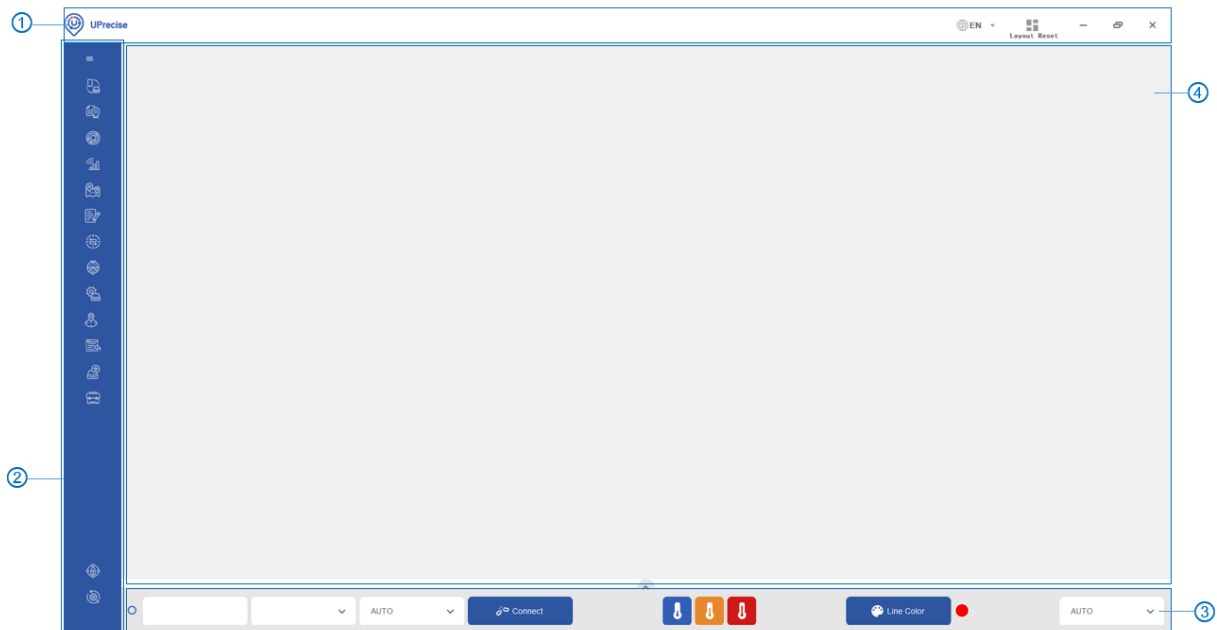

Figure2-1 UPrecise Major Functions

Table2-1 UPrecise Major Functions

1 Title Bar	2 Menu Bar	3 Status Bar	4 Working Area
provides the functions to switch between English/ Chinese and reset the layout	scalable, providing shortcuts to use the related functions	connect, disconnect and switch the receivers	used to display the child windows

### 2.1 Title Bar

The title bar provides the functions of language switch and layout reset.

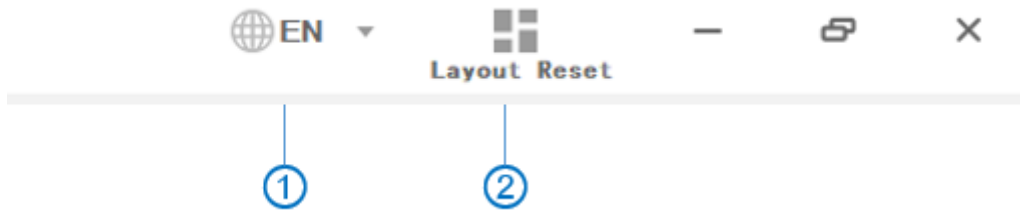

Figure2-2 Title Bar

(1) Language Switch

(2) Layout Reset

## 2.1.1 Language Switch

**Language Switch** feature changes the language displayed in UPrecise. Currently, it supports English and Chinese. The switch takes effect after the software restarts.

## 2.1.2 Layout Reset

After connecting with the receivers, UPrecise displays the windows of **Constellation**, **Data Stream**, **Tracking Status** and **Map** automatically.

The other windows mentioned in **Menu Bar** can be opened and closed manually. When necessary, click **Layout Reset** button to reset the layout.

## 2.2 Status Bar

At the bottom of UPrecise is the **Status Bar**.

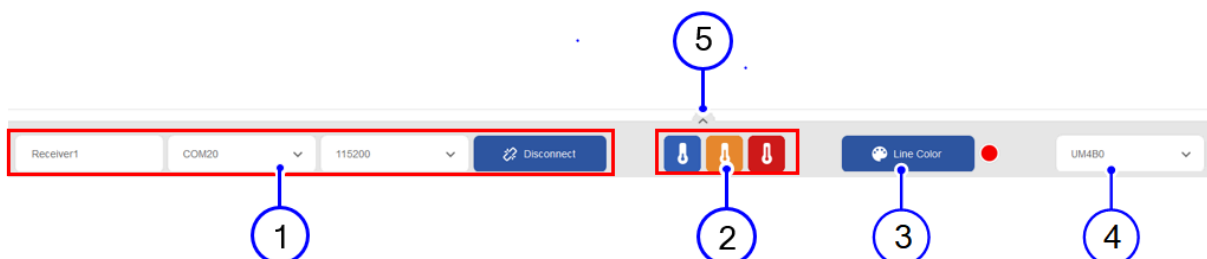

Figure2-3 Status Bar

Table2-2 Status Bar Description

Interface	Description
1 Receiver Information	Related to the <b>Receiver Connection</b> . When the receivers are connected, the information of the selected receiver is automatically displayed here and it controls the disconnection/connection of the receiver.
2 Start Mode	Cold Start (Blue) Warm Start (Orange) Hot Start (Red)
3 Line Color	Decides the trajectory color in the window <b>Map</b> .
4 Product Model	Related to the <b>Receiver Connection</b> . When the receivers are connected, the model of the selected receiver is automatically displayed here. If the identification fails, you can disconnect the receiver and then select the type from the drop-down box. Manually adding product model is also supported, see <a href="#">Manually Add Product Models</a> .
5 Expand	Click this button to show all the connected receivers. Currently, it supports maximum four receivers. See the figure <a href="#">Expand</a> .

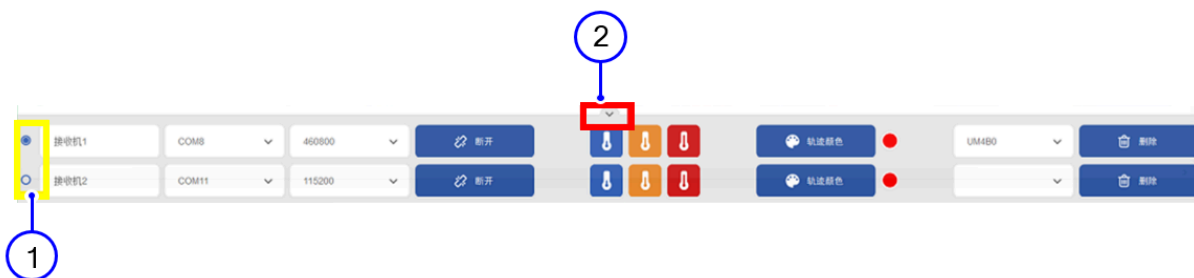

Figure2-4 Expand

Table2-3 Expand Description

Interface	Description
1 Switch	Select the receiver by clicking the radio button.
2 Collapse	Click this button to go back to the original status bar.

## 2.2.1 Manually Add Product Models

Unicore releases new product models before UPrecise updates, you can manually add them by modifying the `config.in` file.

Please following the steps below to add new product models:

1. Open the configuration file `config.in`, enter an English comma after the relevant product series, and add the new model number.

The example shows how to add UB9A0 in the N4 series product list.

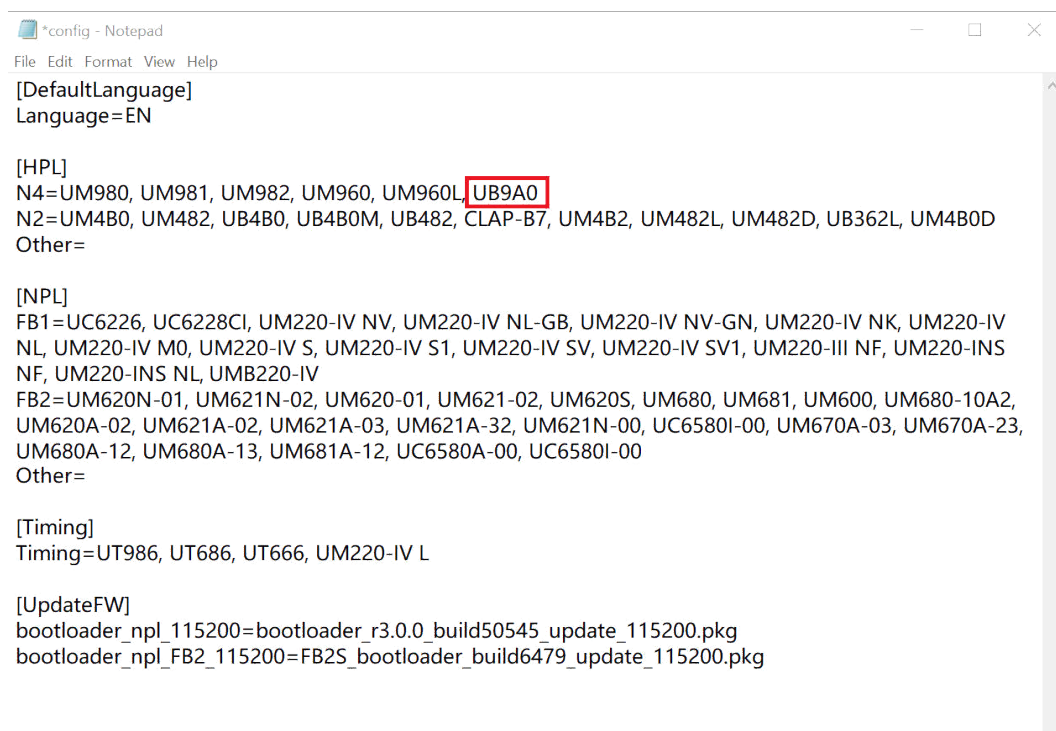

```
*config - Notepad
File Edit Format View Help
[DefaultLanguage]
Language=EN

[HPL]
N4=UM980, UM981, UM982, UM960, UM960L, UB9A0
N2=UM4B0, UM482, UB4B0, UB4B0M, UB482, CLAP-B7, UM4B2, UM482L, UM482D, UB362L, UM4B0D
Other=

[NPL]
FB1=UC6226, UC6228CI, UM220-IV NV, UM220-IV NL-GB, UM220-IV NV-GN, UM220-IV NK, UM220-IV
NL, UM220-IV M0, UM220-IV S, UM220-IV S1, UM220-IV SV, UM220-IV SV1, UM220-III NF, UM220-INS
NF, UM220-INS NL, UMB220-IV
FB2=UM620N-01, UM621N-02, UM620-01, UM621-02, UM620S, UM680, UM681, UM600, UM680-10A2,
UM620A-02, UM621A-02, UM621A-03, UM621A-32, UM621N-00, UC6580I-00, UM670A-03, UM670A-23,
UM680A-12, UM680A-13, UM681A-12, UC6580A-00, UC6580I-00
Other=

[Timing]
Timing=UT986, UT686, UT666, UM220-IV L

[UpdateFW]
bootloader_npl_115200=bootloader_r3.0.0_build50545_update_115200.pkg
bootloader_npl_FB2_115200=FB2_bootstrap_build6479_update_115200.pkg
```

















Figure2-5 Manually Add Model Number

2. Restart UPrecise. The added model number is identified.

## 2.3 Menu Bar

This section gives the introduction of the functions supported by UPrecise, which can be accessed through the shortcuts.

Table2-4 Menu Bar

No.	Button	Description	No.	Button	Description
1		Expand/Collapse the Menu	12		Replay
2		Connections	13		Receiver Upgrade
3		Data Stream	14		Tools, including: CWOUT RTCM KMZ TTF Converter NtripCaster
4		Constellation	15		Platform Locked
5		Tracking Status	16		Platform Settings
6		Map			
7		Message			
8		Discrete Trajectory			
9		Attitude			
10		Receiver Configurations			
11		Data			

## 3 Use UPrecise

This chapter introduces how to use UPrecise features. To ensure the full functionality of UPrecise software, please use it in conjunction with Unicore products.

### 3.1 Preparations

---

To activate all the functions of UPrecise, you need to use it together with Unicore's products.

Before using UPrecise, you need to connect the receivers, antenna and PC correctly. See the figure [Diagram of Connections](#).

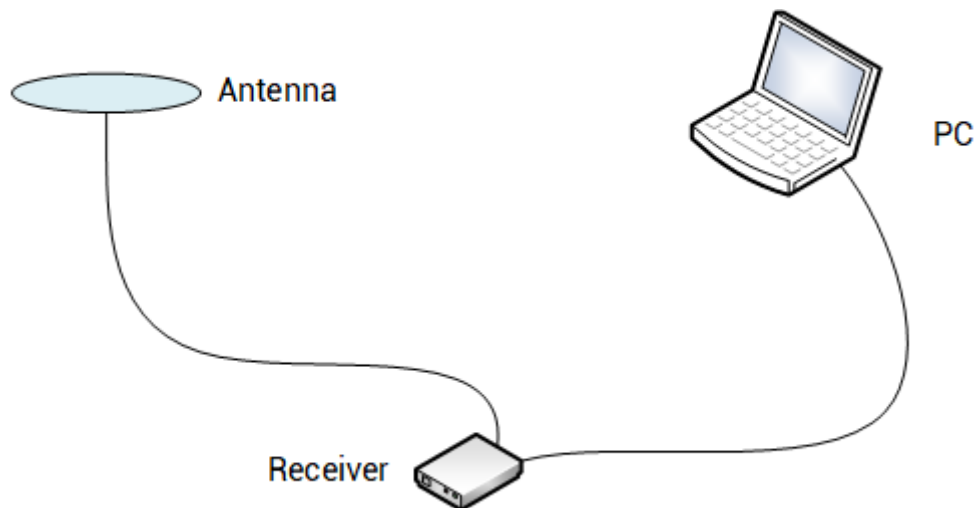

Figure3-1 Diagram of Connections

### 3.2 Connect Receivers

---

#### Steps

Follow the steps below to connect the receiver:

1. Click **Connections** icon to open the window.
2. Choose a way to connect the receiver from the following two options:
  - Serial Port: Type in or select the number of the serial port (check in the device manager) and the baud rate.

**Tip:**

By default, the baud rate is identified automatically, which does not have to be set manually.

- TCP/IP: Type in the IP address of the receiver and the port number.

**Note:**

TCP/IP connection is supported by the receivers that have network functions.

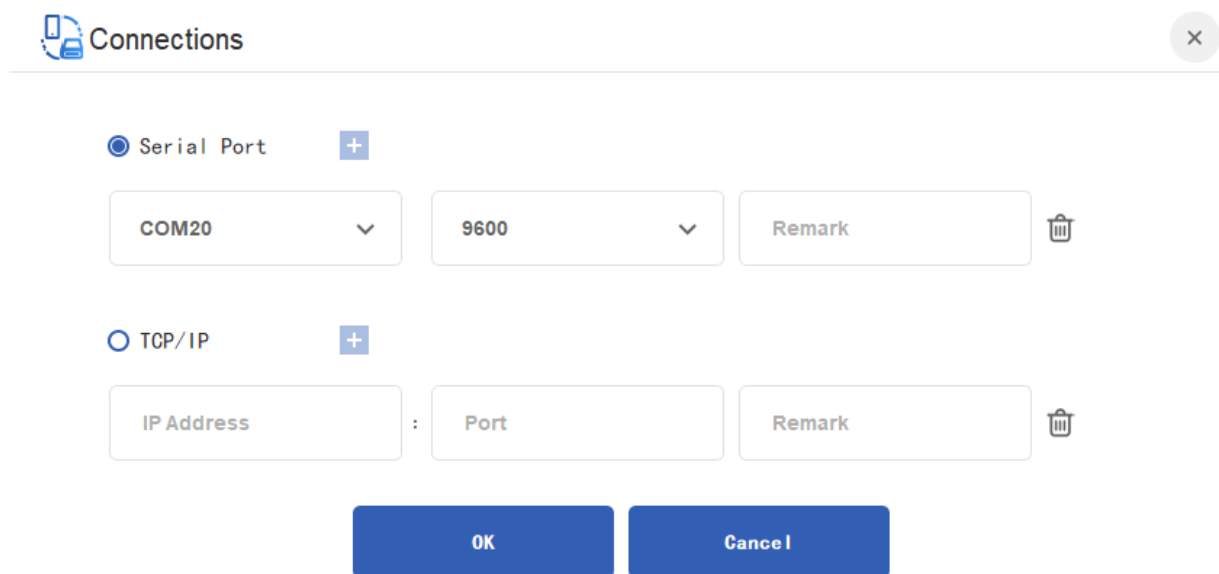

Connections

Serial Port +

COM20 9600 Remark

TCP/IP +

IP Address : Port Remark

OK Cancel

Figure3-2 Connections

3. Click **OK** to complete the connection.

Up to 4 receivers are supported to connect simultaneously.

The four default windows **Constellation**, **Data Stream**, **Tracking Status** and **Map** appear and the port number/IP address and the remark are shown on the status bar.

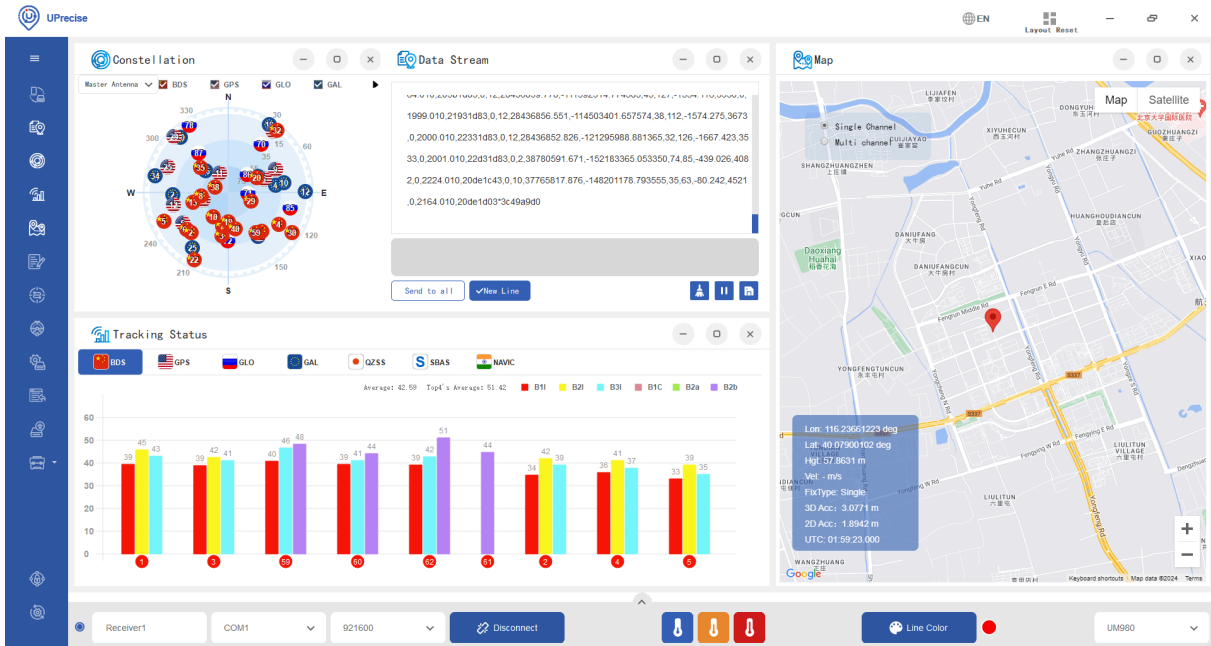

Figure3-3 Default Layout

### 3.3 Data Stream

**Data Stream** displays the raw data in real time and playback, providing a command input box to have a real-time interaction with the receivers.

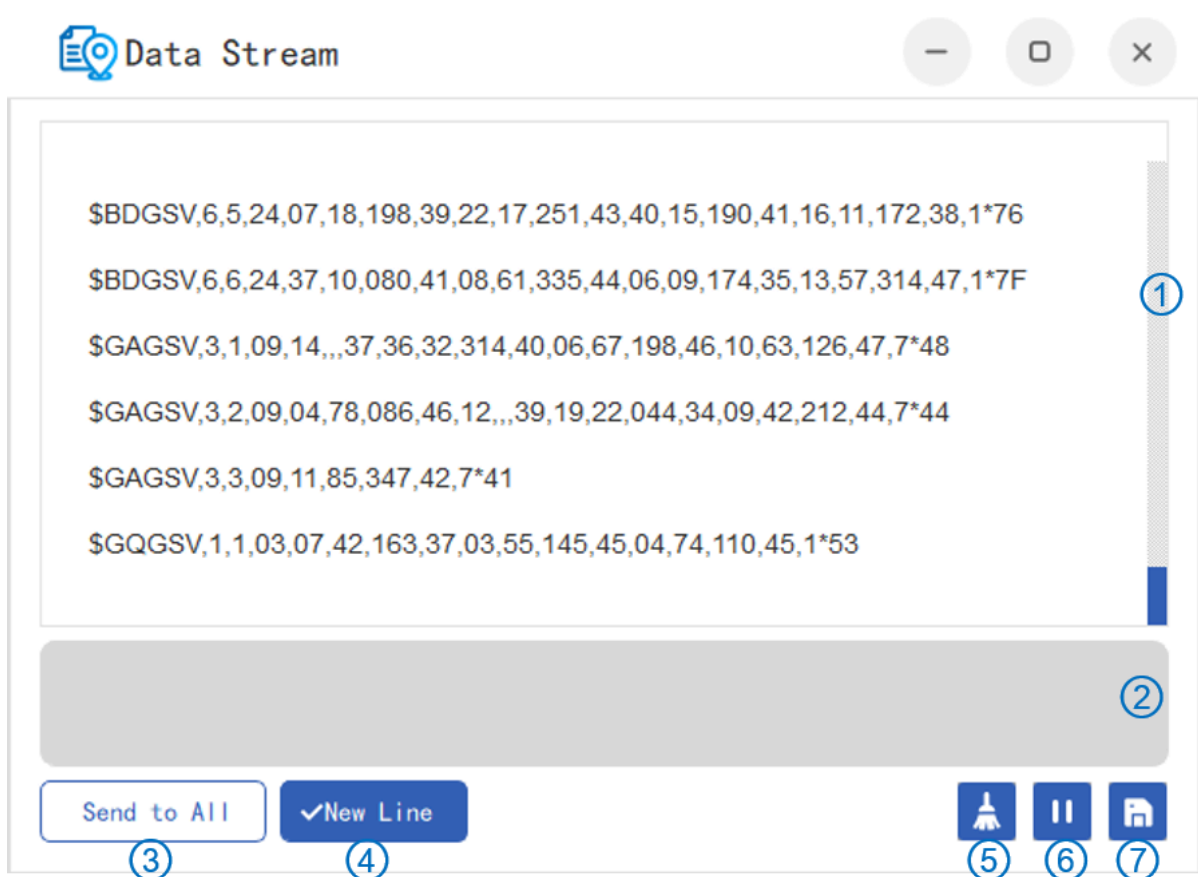

Figure3-4 Data Stream

Table3-1 Data Stream Description

Interface	Description
1 Raw Data Output Window	Output the raw data of the receivers. To output in Binary, you need to configure an ASCII output.
2 Command Input Box	Input a command to interact with the receivers. Use the <b>up</b> and <b>down</b> keys on the keyboard to check the historical commands.
3 Send to All	Send the command to all the connected receivers. UPrecise can connect at most 4 receivers, and <b>Send to all</b> will send the command to all of the connected receivers.
4 New Line	Create a new command and add the <b>CRLF</b> automatically.
5 Clear	Clear all the contents displayed in the output window.
6 Pause	Stop the contents updated in the output window.

Interface	Description
Updating	
7 Save File	Save the raw data of the receivers.

**Note:**

To save data, first click the **save** icon to create and name the log file; second click (after an interval) the **save** icon again to finalize the data saving.

Refer to the corresponding protocol specifications for the commands supported by the receivers.

## 3.4 Constellation

---

After successful connections, UPrecise analyzes the received data and displays all satellites parsed by the receivers in the **Constellation** window.

This window shows a general distribution of the visible satellites in real time or playback. UPrecise supports displaying seven navigation systems:

- GPS
- BDS
- GLONASS
- Galileo
- QZSS
- SBAS
- NavIC

Clicking the national flags can select or deselect the systems. You can distinguish the corresponding satellite systems according to different flag icons.

For the products with dual antennas, you can choose to display the information received from the master antenna (by default) or the slave antenna through the drop-down box.

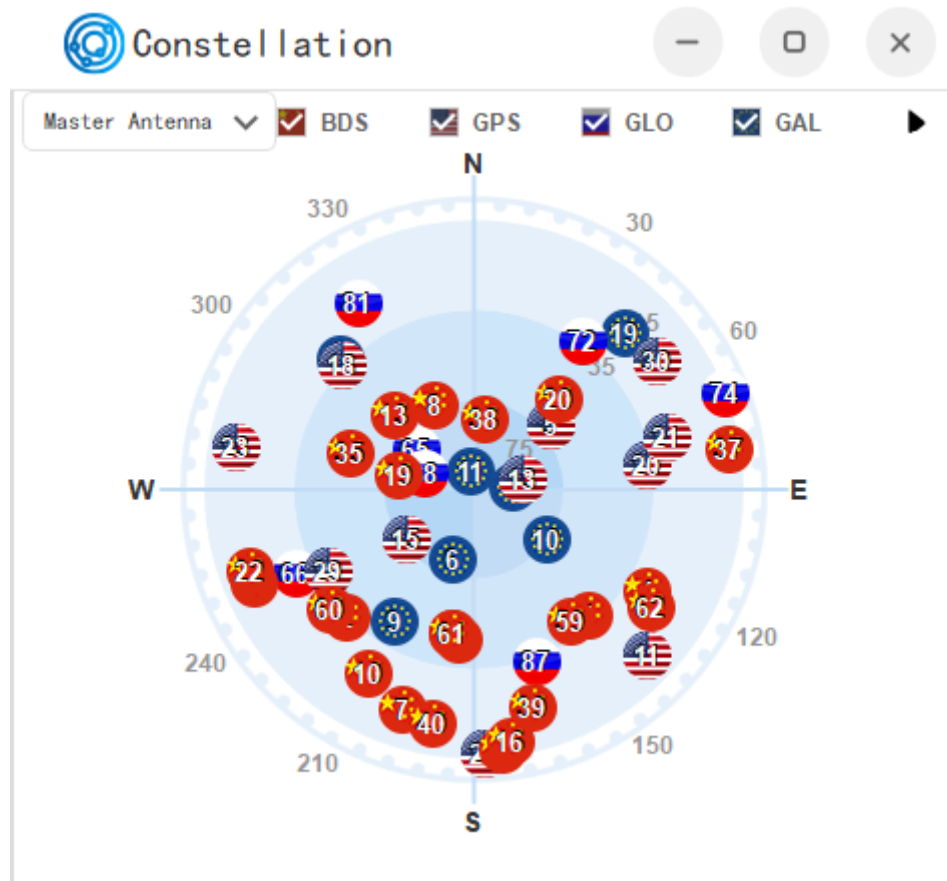

Figure3-5 Constellation

To see the visible satellites, you must enable at least one of the following messages according to the protocols supported by the receivers:

- GSV(GSVH)

**Note:**

Used together with GGA or RMC.

- SATVISA
- SATVIS2A
- SATELLITE
- SATSINFO

## 3.5 Tracking Status

---

**Tracking Status** displays the changes and tracking status of the visible satellites and C/N0 values in real time or playback.

**Tracking Status** displays multiple frequencies of multiple systems including:

- GPS
- BDS
- GLONASS
- Galileo
- QZSS
- SBAS
- NavIC

In the default size, the **Tracking Status** window just displays the satellite numbers of one system and C/N0 values at different frequencies, and displays the average C/N0 value of the current system and the average of the top four C/N0 values.

You can switch between different systems by clicking the flag icons. See the figure [Default Tracking Status](#).



Figure3-6 Default Tracking Status

When the **Tracking Status** window is maximized, it can display maximum four satellite systems and their C/N0 values at different frequencies at the same time, as well as the average C/N0 values and the average of the top four C/N0 values. See the figure [Maximized Tracking Status](#).

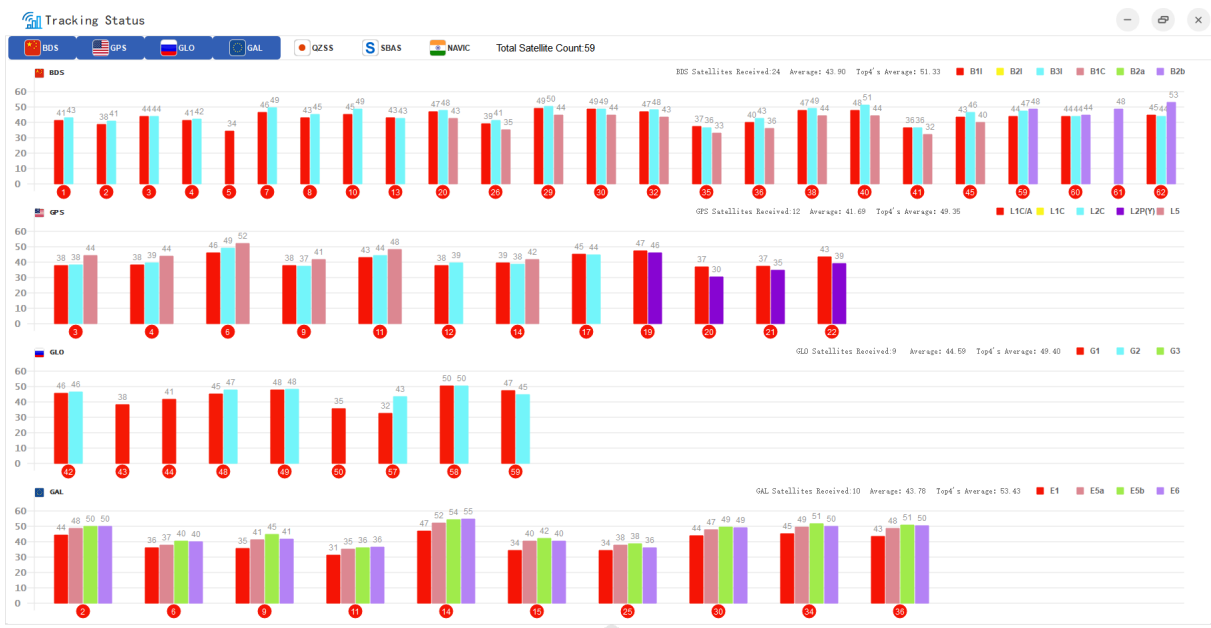

Figure3-7 Maximized Tracking Status

To see the tracking status, enable at least one of the following messages according to the protocols supported by the receivers:

- GSV(GSVH)

**Note:**

Used together with GGA or RMC.

- OBSVMA
- OBSVHA
- SATSINFO

## 3.6 Map

---

The **Map** window shows the positioning information in real time or playback, including the current positioning point and the historical trajectory (the latest 3000 Epochs) drawn on the loaded online map. See the figure [Map](#).

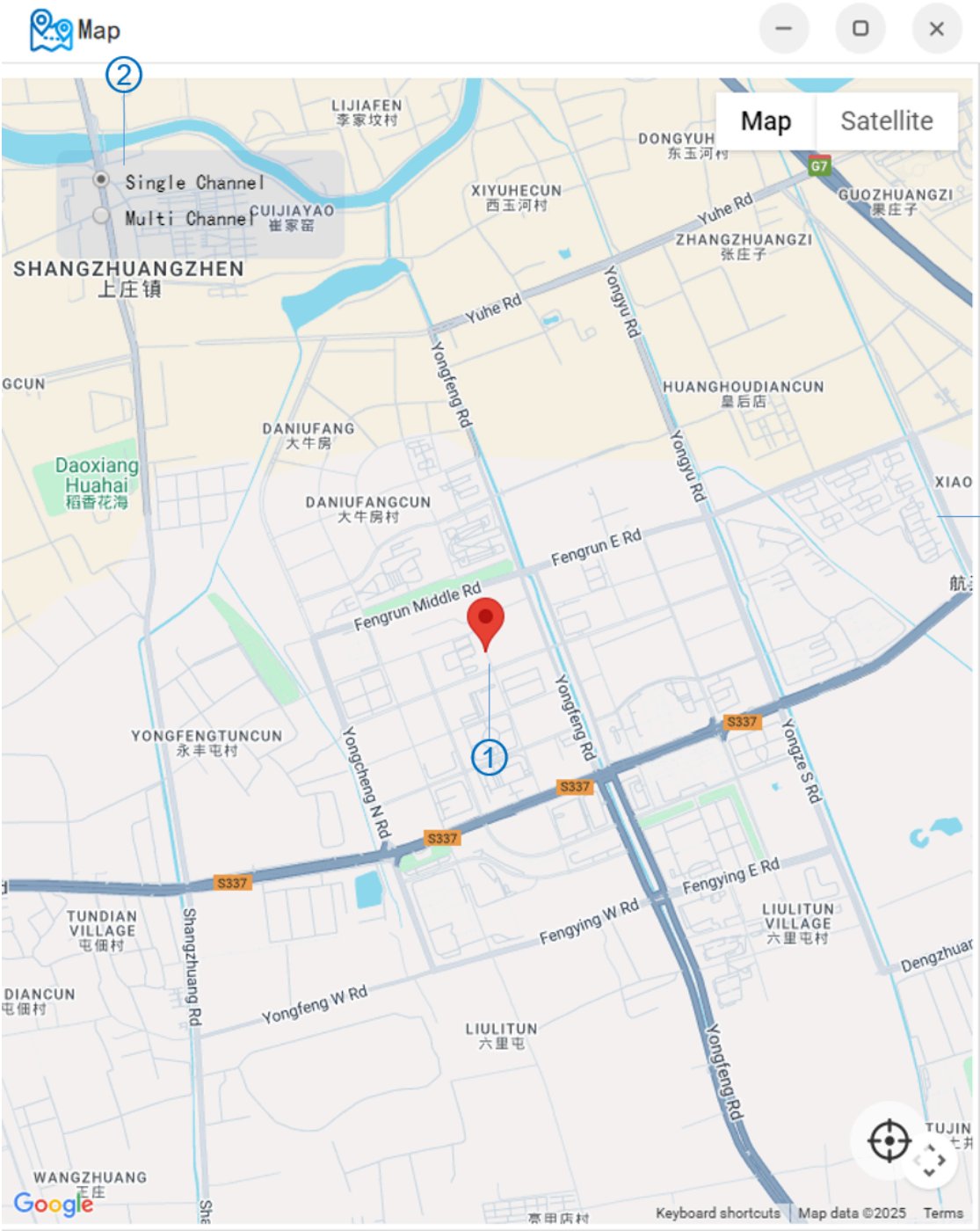

Figure3-8 Map

- (1) Positioning point
- (2) Centering button
- (3) Loaded map

**Tip:**

Click the **Data** icon on the **Menu Bar** to open or close the location data of the positioning point.

This function is particularly suitable for driving tests to view the positioning trajectory.

If there are more than one receivers connected, you can select the **Multi Channel** to see the trajectories of all the receivers.

If Google Maps failed to load, a warning window will appear and you can choose to switch to Baidu Maps.

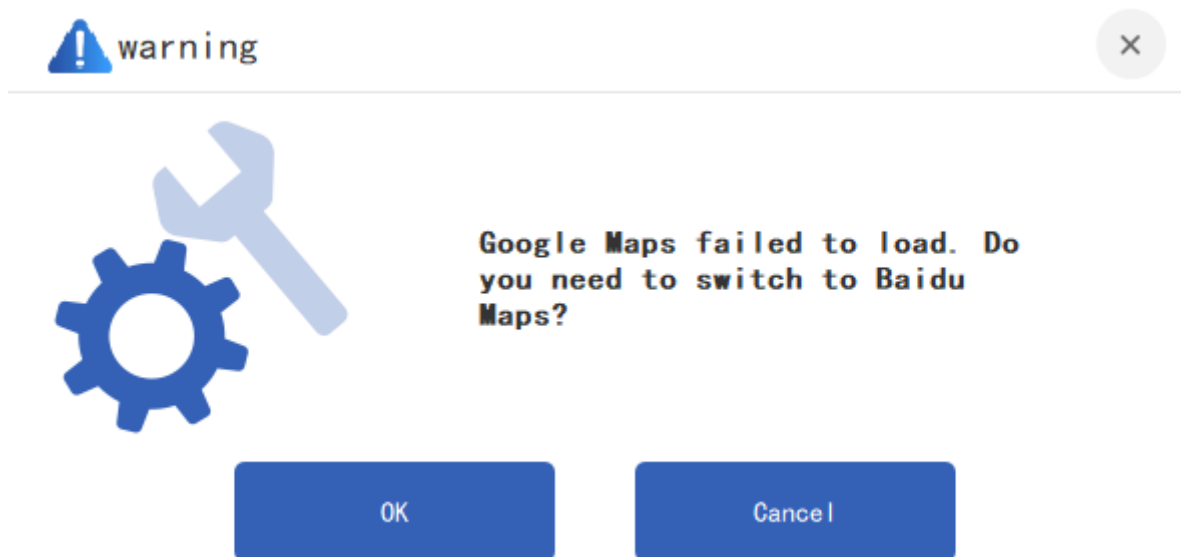

Figure3-9 Google Map Loading Failure

To display the positioning information, enable at least one of the following messages according to the protocols supported by the receivers:

- GST (GSTH)
- GGA (GGAH)
- RMC (RMCH)

## 3.7 Message

After connections, UPrecise parses the data received by the receiver and dynamically displays the results matched with the type of the receiver in the **Message** window.

UPrecise supports parsing common messages. Refer to the related protocol manuals for details.

**Note:**

Messages of NMEA h30 version are not supported.

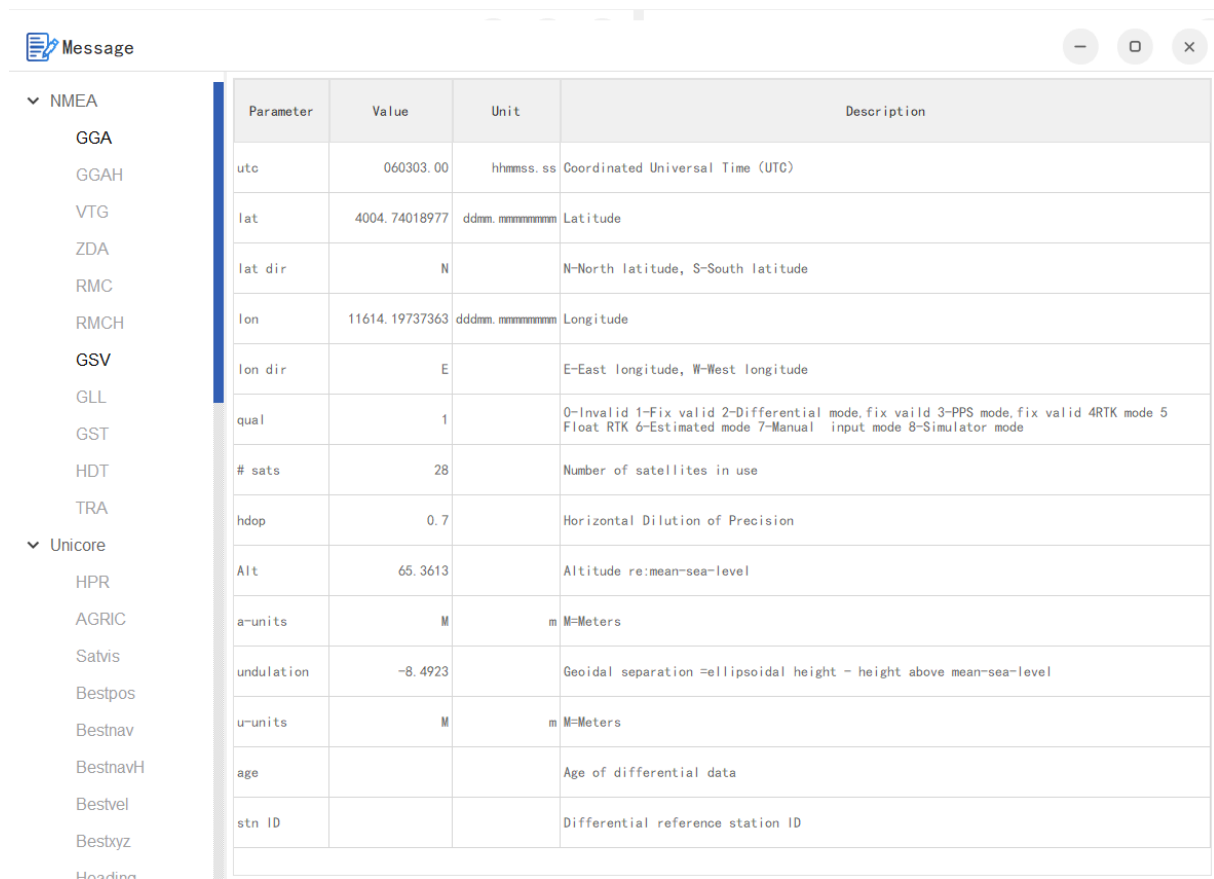

Parameter	Value	Unit	Description
utc	060303.00	hhmmss.ss	Coordinated Universal Time (UTC)
lat	4004.74018977	ddmm.mmmmmmm	Latitude
lat dir	N		N-North latitude, S-South latitude
lon	11614.19737363	dddmm.mmmmmmm	Longitude
lon dir	E		E-East longitude, W-West longitude
qual	1		0-Invalid 1-Fix valid 2-Differential mode, fix valid 3-PPS mode, fix valid 4-RTK mode 5-Float RTK 6-Estimated mode 7-Manual input mode 8-Simulator mode
# sats	28		Number of satellites in use
hdop	0.7		Horizontal Dilution of Precision
Alt	65.3613		Altitude re:mean-sea-level
a-units	M	m	M=Meters
undulation	-8.4923		Geoidal separation =ellipsoidal height - height above mean-sea-level
u-units	M	m	M=Meters
age			Age of differential data
stn ID			Differential reference station ID

Figure3-10 Message

## 3.8 Discrete Trajectory

The **Discrete Trajectory** window shows the longitude and latitude of the positioning point, as well as the horizontal discrete degree in real time or playback.

When the receiver tracks static signals, you can zoom in/out to view the horizontal discrete degree in different scales. You can also click the **Center on the current point** button to see the position changes.

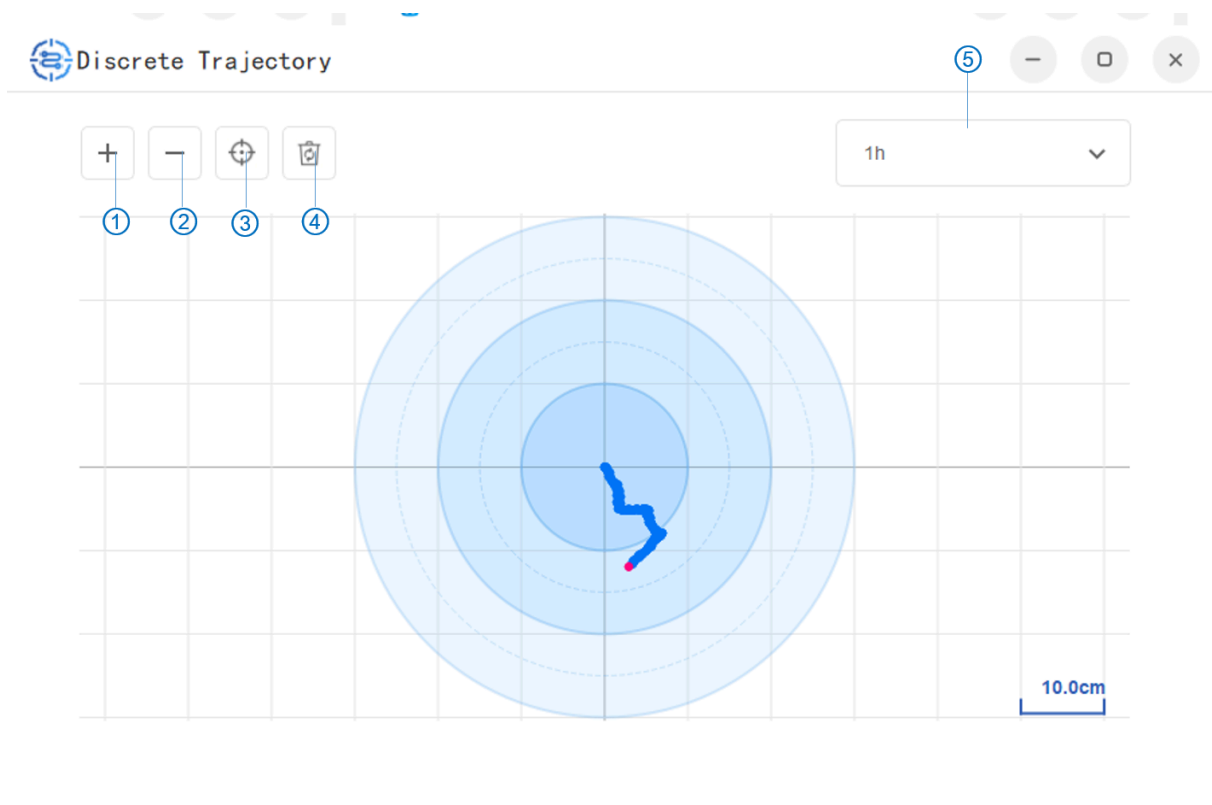

Figure3-11 Discrete Trajectory

- (1) Zoom in
- (2) Zoom out
- (3) Center on the current point
- (4) Clear
- (5) Show duration

## 3.9 Attitude

The **Attitude** window displays the information of positioning and attitude, including position, velocity, angle, acceleration, angular acceleration and positioning/INS status.

In the default size window, **Attitude** just displays the attitude information, which is the direction information.

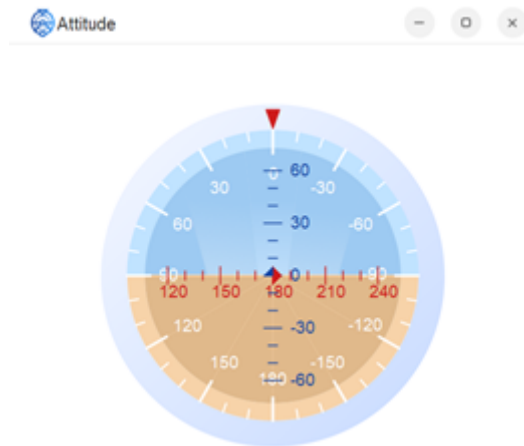

Figure3-12 Attitude View – Default Size

In the maximized window, **Attitude** displays the positioning and attitude information simultaneously. See [Attitude View – Maximum Size](#). The left figure is that showed in the normal size providing the attitude information, and the information on the right provides the positioning and attitude values.



Figure3-13 Attitude View – Maximum Size

To see the information of positioning and attitude, you must enable at least one of the following messages according to the protocols supported by the receivers:

- HDT

- INSPVAA
- RAWIMUXA
- UNIHEADING

## 3.10 Receiver Configurations

UPrecise enables configuring the parameters of the receivers according to its type. Refer to the related protocol manuals for the configuration details for specific receiver models.

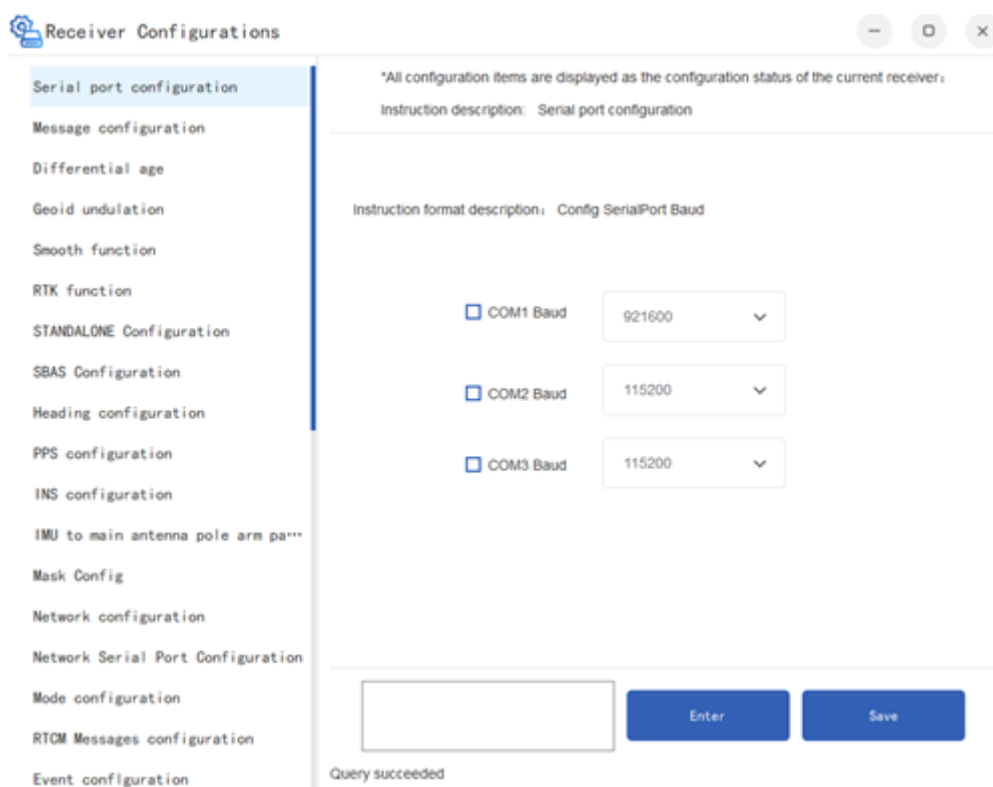

Figure3-14 Receiver Configurations

## 3.11 Data

The **Data** window displays the location data of the positioning point, including longitude, latitude and height. See the figure [Positioning Point Data](#).

Click the **Data** icon to open or close the window. See the figure [Data](#).

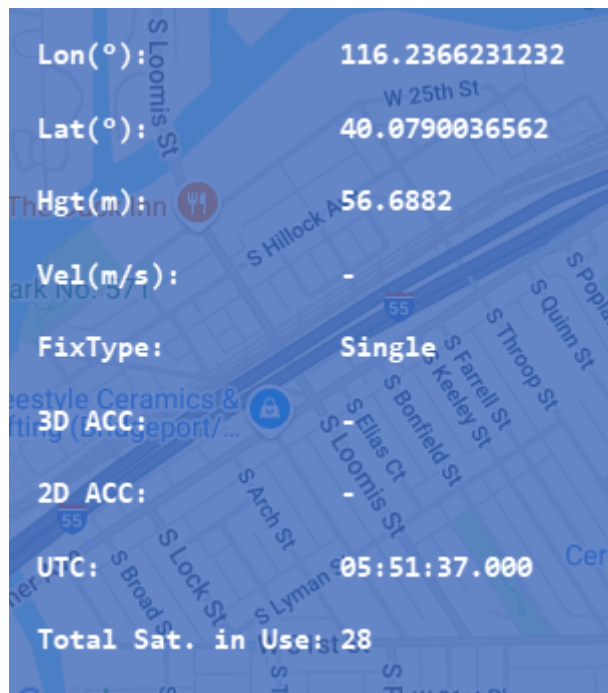

Figure3-15 Positioning Point Data

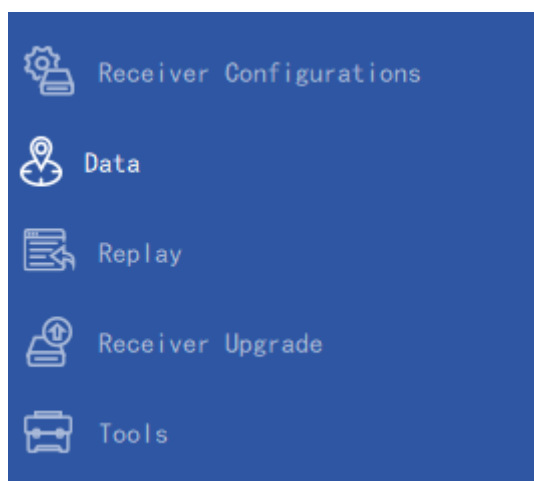

Figure3-16 Data

## 3.12 Replay

---

UPrecise can replay the saved data for Unicore products.

### Prerequisites

Save the data for replaying before using the Replay feature.

### Steps

When the receivers are connected, do the following steps to save the data:

1. Click the **save** icon in **Data Stream** window.
2. Create the filename and choose a directory to save the data file.

**Tip:**  
Manually entering a directory is supported.

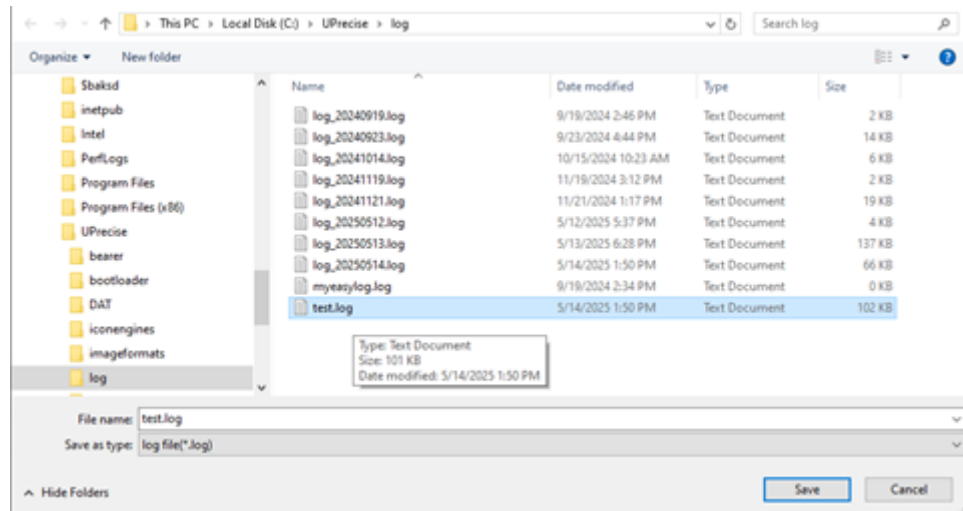

Figure3-17 Create Data File

3. Wait for an interval of time, click the **save** icon in **Data Stream** window again, to finalize the saving.

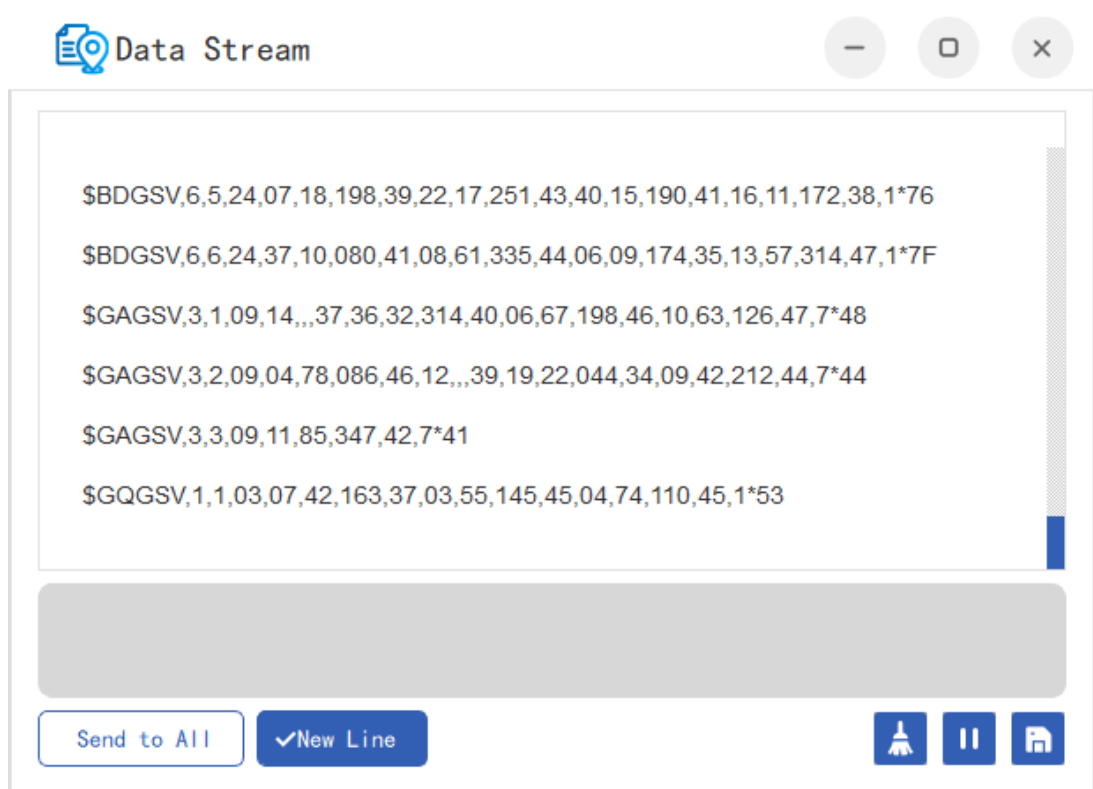

Figure3-18 Save Data File

## Steps

When the data file is saved, do the following steps to replay the data:

1. Click the **Replay** icon on the menu bar to open the **Data Replay** dialog box, and click **OK** to open the **Data Replay** window.

UPrecise exits from the real-time monitoring and cuts the connection with the receivers.

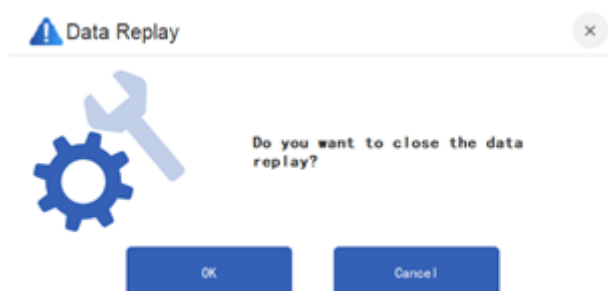

Figure3-19 Replay

2. Click **...** to open the file selection window, and select the data file saved before.

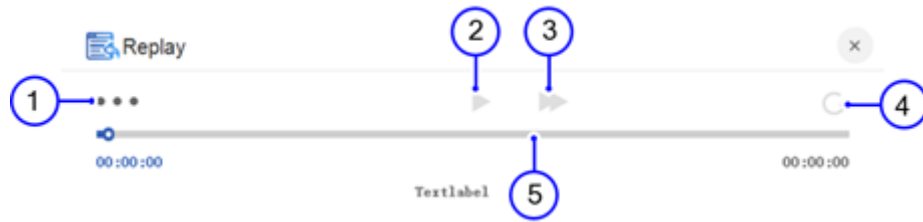

Figure3-20 Replay Window

- (1) File selection
- (2) Start
- (3) Forward
- (4) Replay
- (5) Progress bar

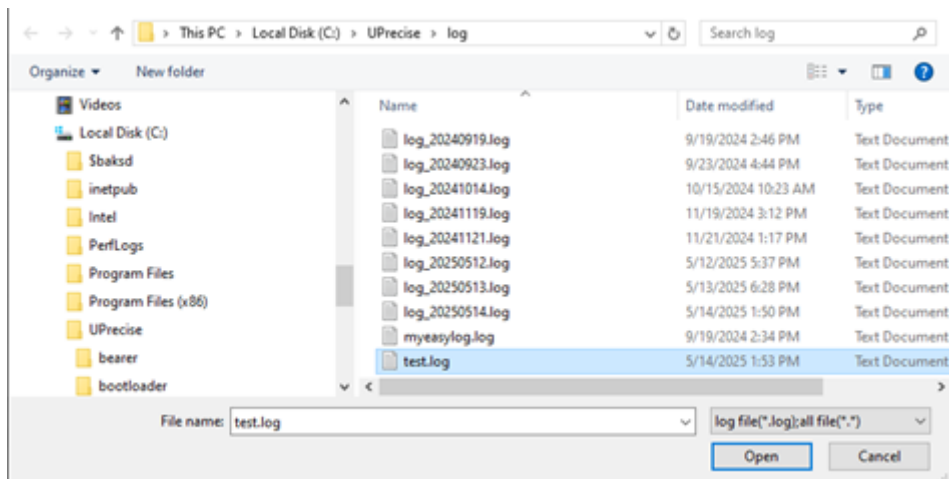

Figure3-21 Select File

3. Click **Open** to replay the data.

If you want to quit the replay, click **×** button and then click **Ok**.

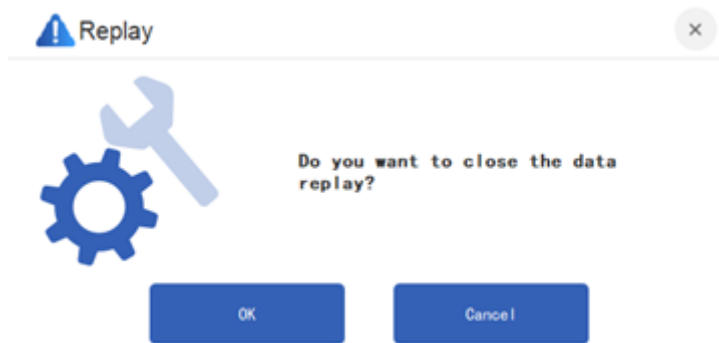

Figure3-22 Quit Replay

## 3.13 Receiver Upgrade

UPreicse provides the **Receiver Upgrade** function to upgrade the firmware of Unicore receivers.

**Note:**

The receiver upgrade function does not support UM68X series products currently. If you need to upgrade UM68X series, please contact our FAE.

Do the following steps to upgrade the receiver:

1. Click **Receiver Upgrade** icon to open the **Receiver Upgrade** dialog box.
2. Click **Select upgrade file** and choose the upgrade file prepared.



Figure3-23 Select Upgrade File

3. Click the check box to select the target receiver name. The same type of receivers can be upgraded simultaneously.
4. Resetting the receiver is required for upgrading. Select one of the following reset options:
  - Soft reset. UPrecise resets the receiver.
  - Hard reset. Manually reset the receiver.
5. Click **Start** to upgrade the firmware. The progress bar indicates the firmware upgrade progress.

**Note:**

Do not interrupt the upgrade process during operation, as this will result in upgrade failure.

6. Click **x** to exit when the upgrading is completed.

### 3.13.1 Upgrade with Upgrading File

When Unicore updates a product before UPrecise is updated in time, an update loader and a new **config.ini** file will be provided for users to upgrade the receiver.

Do the following steps to upgrade the receiver:

1. Replace **config.ini** in the installation path with the new version.

2. Copy and paste the update loader in the bootloader folder.

Uprecise > 5.SW > release

名称	修改日期	类型	大小
bearer	2024/6/12 19:25	文件夹	
bootloader	2024/6/12 19:25	文件夹	
DAT	2024/7/4 14:02	文件夹	
iconengines	2024/6/12 19:26	文件夹	
image	2024/6/12 19:26	文件夹	
imageformats	2024/6/12 19:26	文件夹	
log	2024/8/2 9:26	文件夹	
map	2024/7/30 15:53	文件夹	
MessageConfig	2024/7/4 14:01	文件夹	
platforms	2024/6/12 19:26	文件夹	
position	2024/6/12 19:26	文件夹	
printsupport	2024/6/12 19:26	文件夹	
resources	2024/6/12 19:26	文件夹	
styles	2024/6/12 19:26	文件夹	
ntripcaster.conf	2024/3/25 14:28	CONF 文件	2 KB
app.ico	2022/2/15 13:57	ICO 文件	17 KB
packUPrecise.iss	2024/7/26 10:02	Inno Setup Script	3 KB
AgnessConfig.ini	2023/11/13 9:51	配置设置	2 KB
config.ini	2024/8/2 9:51	配置设置	1 KB
Converter.exe	2024/5/31 15:59	应用程序	1,859 KB
NtripCaster.exe	2024/3/25 14:28	应用程序	74 KB
QtWebEngineProcess.exe	2020/11/12 21:42	应用程序	578 KB
UPrecise.exe	2024/7/31 14:20	应用程序	2,145 KB
UPreciseAGNSS.exe	2024/6/20 15:00	应用程序	383 KB
ConfigViewModules.dll	2024/7/26 9:52	应用程序扩展	1,233 KB
D3Dcompiler_47.dll	2022/1/28 14:38	应用程序扩展	4,077 KB
GNSSDecode.dll	2024/7/31 14:01	应用程序扩展	365 KB

Figure3-24 Bootloader

## 3.14 Tools

The section introduces the tools supported by UPrecise.

### 3.14.1 Interference Detection (CWOUT)

Interference Detection (CWOUT) is used to detect the interference strength at the frequencies of 1575.42 MHz (L1), 1227.60 MHz (L2) and 1176.45 MHz (L5).

The indicators are as follows:

The indicators are as follows:

- Green – No CWOUT
- Orange – CWOUT exists
- Red – Strong CWOUT



Figure3-25 Interference Detection

The figure above shows the real-time interference strength at the three frequencies.

The three figures below record the variation of the interference strength from the start of the detection to the current state. The abscissa is the number of detections and the ordinate is the interference strength with a range of 0 to 255.

The larger the interference is, the more effect it has on the positioning.

**Note:**

To use the Interference Detection feature, the receivers need to support the message `FREQJAMSTATUS`.

### 3.14.2 RTCM Monitor

Use the **RTCM Monitor** to broadcast differential corrections and achieve RTK positioning.

**Steps**



To use the **RTCM Monitor**, set Input first and then set the Output.

### Sub-steps A

To set the Input, follow the steps below:

1. Click **Tools > RTCM Monitor** to open the **RTCM Monitor** window.
2. Click **Input** to open the **RTCM Input** window. Choose one option from the dropdown menu to set the input. Four options are supported for data input:
  - Serial Port
  - Ntrip Server
  - IC-to-Cloud

**Note:**

The IC-to-Cloud service is provided by Unicore and TruePoint jointly. Through the integrated SDK, the receiver can get data from the TruePoint cloud platform, and achieve more precise and faster positioning.

For information or support during the use of IC-to-Cloud, contact Unicore FAE.

- File

**Note:**

The file must adhere to the RTCM standard protocol, and the **RTCM Monitor** tool will replay the data sequentially per second according to the embedded timestamps.

Refer to the table [RTCM Input and Output](#) when choosing the input option.

RTCM Input
×

IC-to-Cloud
▼

User:

Dev ID:

Freq:

IP:

Block Time:

Password:

Mount Point:

Auth Type:

Port:

Coordsys:

Description: This connection method only supports some chips. Please contact the staff for details

OK
Cancel

Figure3-26 RTCM Input

Table3-2 RTCM Input and Output

Receiver Role	Input	Output
Receiver as base station	Serial Port	Ntrip Server
Receiver as rover	Ntrip Client or IC-to-Cloud	Serial Port Up to 4 receivers supported.

3. Click **OK** to complete setting the Input.

### Sub-steps B

To set the Output, follow the steps below:

1. Click **Output** to open the **RTCM Output** window. Choose one option from the dropdown menu to set the output. Refer to the table [RTCM Input and Output](#) when choosing the input option.

Serial Port ▼

Serial Port

Ntrip Server

---

<input type="checkbox"/>	<input style="width: 95%;" type="text"/>	▼	<input style="width: 95%;" type="text" value="115200"/>	▼
<input type="checkbox"/>	<input style="width: 95%;" type="text"/>	▼	<input style="width: 95%;" type="text" value="115200"/>	▼
<input type="checkbox"/>	<input style="width: 95%;" type="text"/>	▼	<input style="width: 95%;" type="text" value="115200"/>	▼
<input type="checkbox"/>	<input style="width: 95%;" type="text"/>	▼	<input style="width: 95%;" type="text" value="115200"/>	▼

OK

Cancel

Figure3-27 RTCM Output

2. Click **OK** to complete setting the output.
3. Click **Connect** to start.
4. **Optional**  
Check the **Hex** (hexadecimal) box to display the RTCM data in the dialog.

### 3.14.3 KMZ

The **KMZ** tool converts the log file into the KMZ file which can be used by Google Earth.

To use the **KMZ** tool, follow the steps below:

1. Click **Open Log** to add the log file. Up to 16 files are supported.

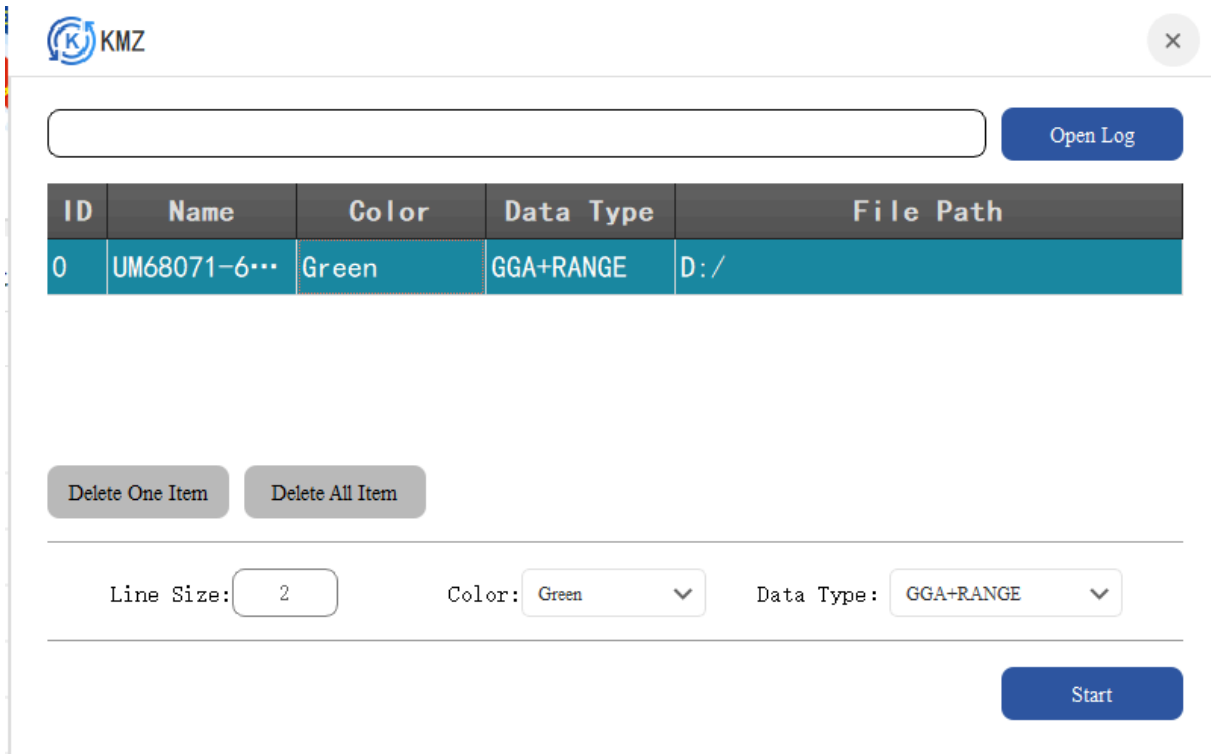

Figure3-28 KMZ

2. Choose one of the logs, and set the **Line size**, **Color** and **Data Type** to change the style:
  - The **Line size** and **Color** decide the trajectory format shown on Google Earth.
  - The **Data Type** decides which kind of message in the log will be converted into KMZ.
3. Click **Start**. The progress bar shows the conversion progress.

### 3.14.4 TTFF Testing

**TTFF** is used to test the TTFF of cold start, hot start and warm start. For the receivers supporting RTK positioning, it can also output the RTK Fix time.

To use **TTFF**, follow the steps below:

1. Click the **TTFF** icon to open the window.
2. Choose a way to retrieve the ephemeris from the following options:
  - **RX Service**. Enable the AGNSS function when using RX Service. Use the command **CONFIG AGNSS ENABLE** can enable AGNSS for NebulasIV series

products.

- Self-Built Ntrip Service. Ntrip Service only supports Version 1.0. When using this service, make sure that the uploading frequency of the source Ephemeris is 1 Hz. It does not support sending the position and TCP.
- Import local ephemeris files.
- No input.



Figure3-29 TTFF Input

3. Complete the following configuration:

(1) Select a serial port not used by other programs and a valid brad rate.

(2) Input the **Test Number** to set how many times to test.

(3) **Optional**

Enter information including latitude, longitude and height and check **Send location simultaneously** box. The location is sent to the receiver to accelerate positioning when **Step 4** is followed.

(4) **Optional**

Input the **Leap Second** and check **Send time simultaneously** box. The time is sent to the receiver to accelerate positioning when **Step 4** is followed.

(5) **Optional**

Input the **Accuracy Threshold**, **Horizontal Offset**, **Vertical Offset**, **Time Offset** and **Test Interval**.

**Accuracy Threshold**: Defines the maximum allowable difference between test results and ground truth values. Results are validated if and only if the error  $\leq$  threshold.

**Horizontal Offset**, **Vertical Offset**, **Time Offset**: To correct the true values entered on the left. Since there may be deviations between the user-input true value and the actual position, when a fixed bias is observed between test results and the input values, users can set an offset value to adjust the ground truth. Adjusted True Value = Original Ground Truth + Offset.

- **Horizontal Offset** Horizontal offset (meters): Northeast = positive, Southwest = negative

- **Vertical Offset** (meters): Up = positive, Down = negative
- **Time Offset** (seconds): Absolute value
- **Test Interval**: Specifies the waiting time between consecutive TTFF tests. After completing the first test, the software will pause for the specified seconds before initiating the next test cycle.

(6) Select the **RTK** to test the RTK fix time of the receiver with RTK positioning capability.

(7) Choose a way to start from **Cold Start**, **Hot Start** and **Warm Start**.

(8) Click **Save Path** to set the path to save the log.

#### 4. Prerequisites for testing:

(1) The receiver outputs GGA messages.

(2) AGNSS enabled if accelerating TTFF with AGNSS is needed.

(3) After sending the commands to enable GGA and AGNSS, save the commands.

Click **Start** to initiate the test. The test result is displayed on the right. The the indicator may provide the following information:

- During a normal test process, the indicator blinks.
- If an error occurs, the indicator becomes gray.
- After a successful test, the indicator keeps green.

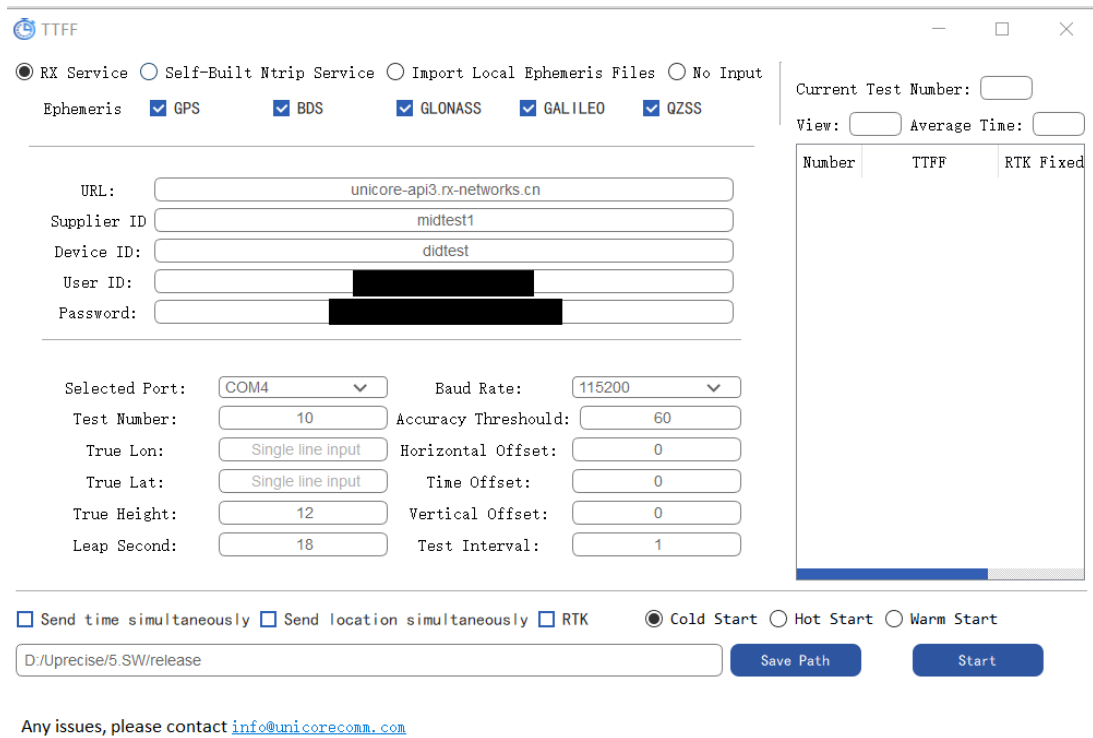

Figure3-30 TTFF Output

5. Click **Stop** and then in the dialog box click **Yes** to exit.

### 3.14.5 Converter

The **Converter** tool supports the conversion of data between ASCII, Binary and Rinex formats.

The following example shows how to convert a file to Rinex format.

1. Click **Open** and select the log to be converted.

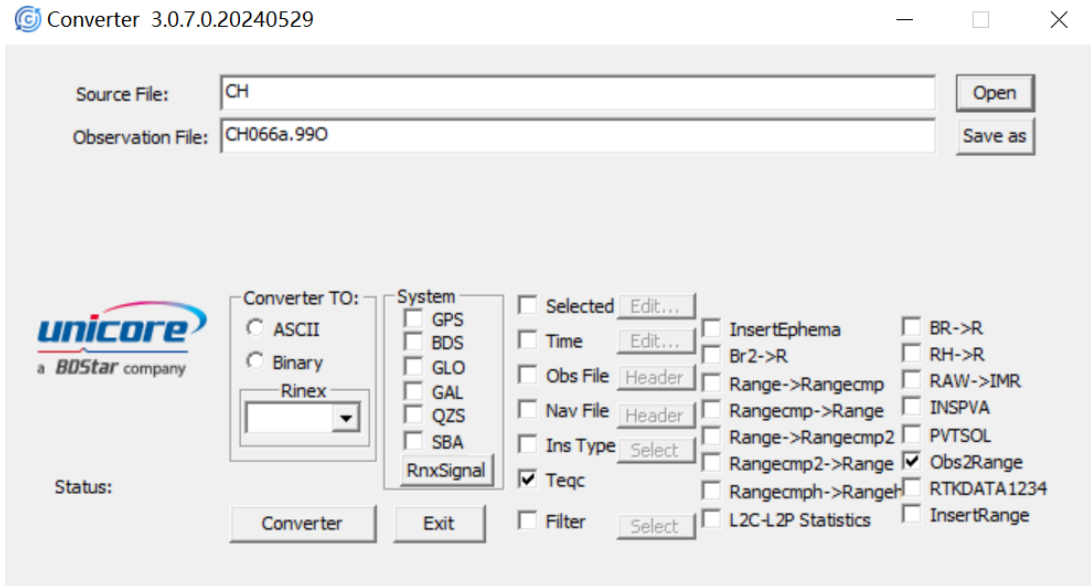

Figure3-31 Converter-1

2. Click the target format under **Converter to**.

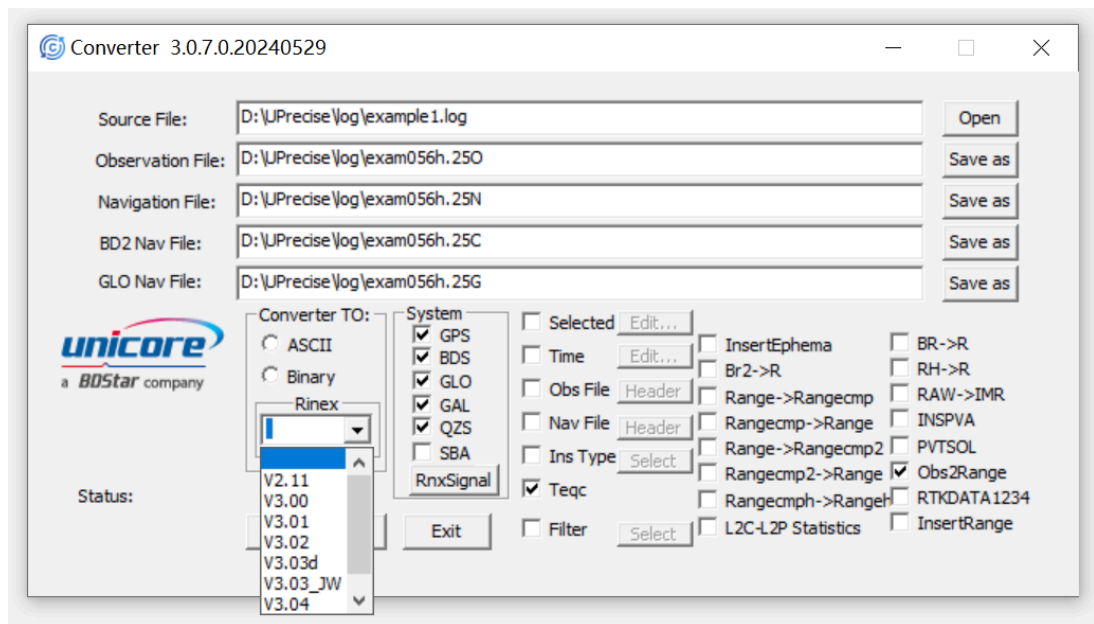

Figure3-32 Converter-2

3. **Optional**

Click **Save as** to change the filename and designate filepath.

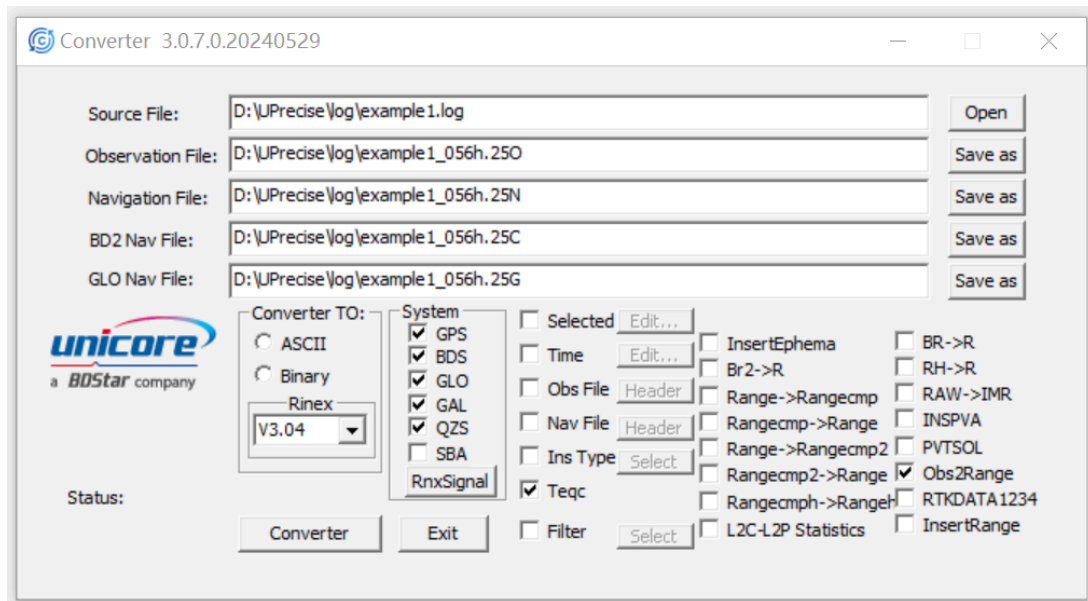

Figure3-33 Converter-3

#### 4. Optional

To use more features, see [Converter-4](#).

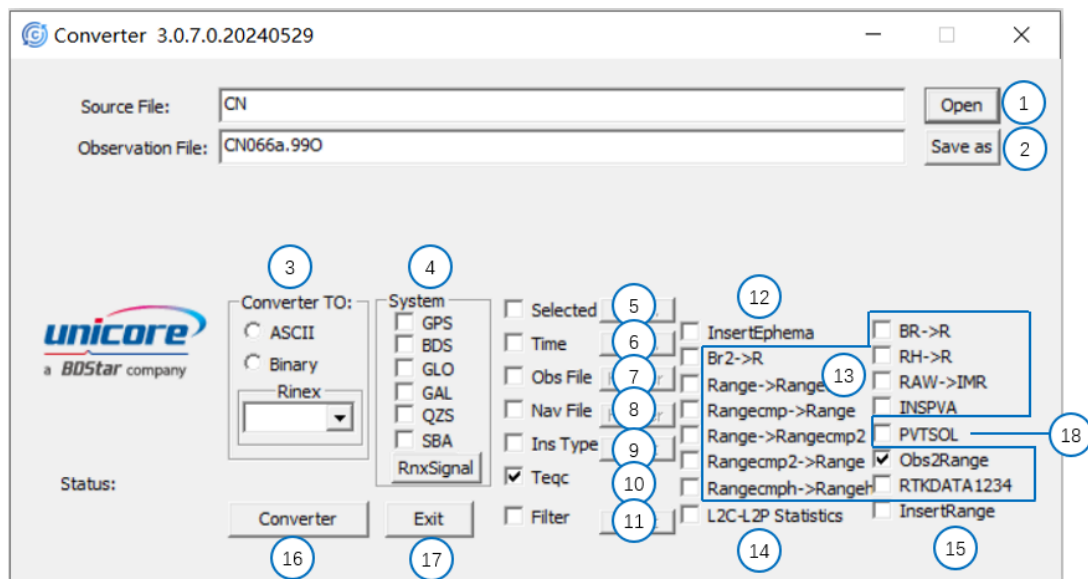

Figure3-34 Converter-4

(1) Open the log file

(2) Change filename and file path

(3) Choose target format

(4) Choose the systems and frequencies to convert



- (5) Choose the messages to convert
  - (6) Set the time to start and stop the conversion
  - (7) Set the message header of the observation file
  - (8) Set the message header of the navigation file
  - (9) Internal feature for UPrecise developer
  - (10) Enabled to guarantee TEQC post-processing stability. Disable this option if your processing software already supports newly launched satellites.
  - (11) Filter satellites and frequencies in RANGE statements(Checked items = Kept; Unchecked items = Filtered)
  - (12) Insert Ephemeris: Merge satellite ephemeris data from an external file into the current file
  - (13) Convert messages
  - (14) Internal feature for UPrecise developer
  - (15) Insert RANGE Statements into Base Range File
  - (16) Start the conversion
  - (17) Exit
  - (18) Internal feature for UPrecise developer
5. Click **Converter** to start converting the format.

### 3.14.6 NtripCaster

UPrecise supports NtripCaster which enables the handshake between Client and Source by configuring the idle listening port, and the upload password, the download name and password can be configured.

UPrecise supports NtripCaster to manage client-source handshake through configurable parameters including idle listening port, upload password and download name & password.

Follow the steps below to set NtripCaster :

1. Click **NtripCaster** icon to open the window.

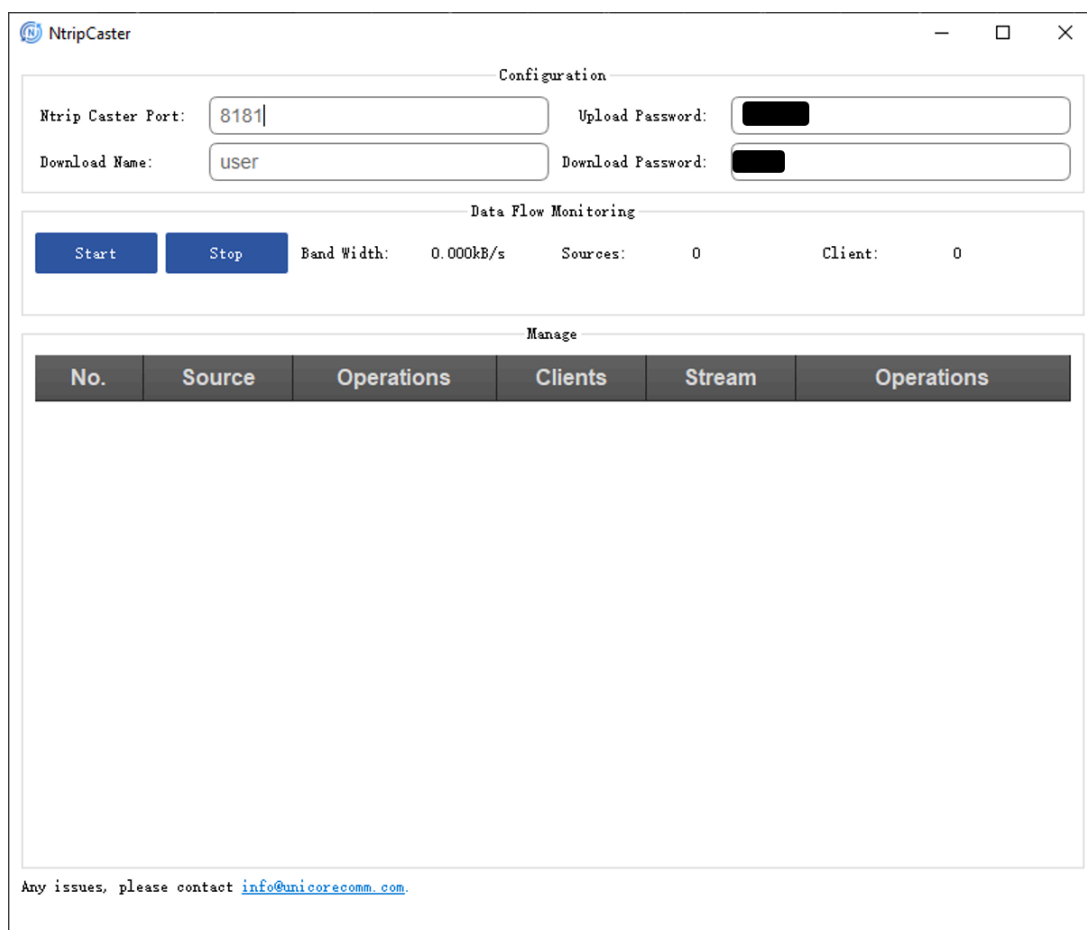

Figure3-35 NtripCaster Window

2. Click **Start** to show the following information:

- bandwidth stream,
- the number of connected Source,
- the number of Client.

Click the **Delete** or **Disconnect** button to delete or disconnect the source and Client.

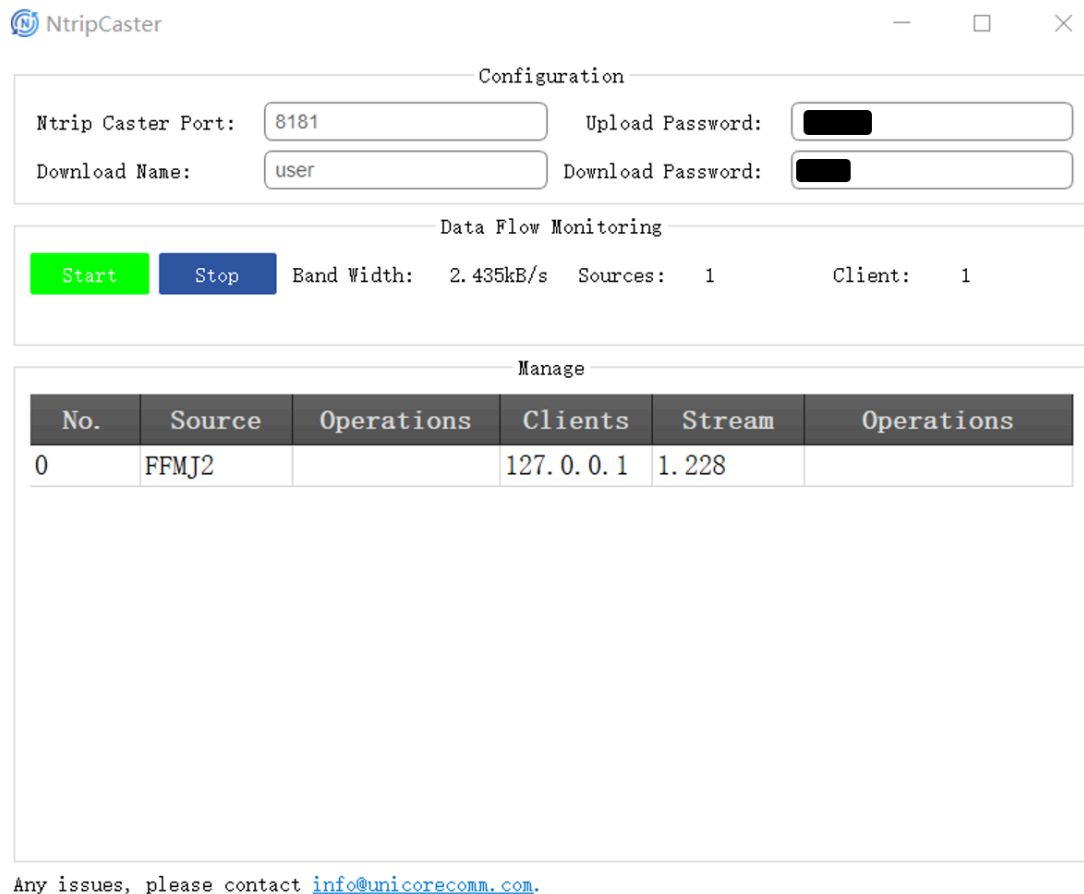

Figure3-36 NtripCaster Information

When NtripCaster configuration is completed, users can connect to the NtripCaster using the **RTCM Monitor** feature. See [RTCM Monitor](#).

## 3.15 Platform Settings

**Platform Settings** sets the platform lock and the path to save the log file, as well as displays the version information.

Follow the steps below to use **Platform Lock** :

1. Click **Platform Lock** to open the window.
2. Set the following items:
  - (1) Check the **Lock-up Time** option.
  - (2) Select the time until auto-lock activates from the dropdown menu.

**Tip:**

After **Step 2**, clicking **Platform Lock** icon in the menu bar will immediately force UPrecise into a locked state.

(3) Set **Password**.

**Note:**

Passwords reset when you quit UPrecise. Set a new password to lock UPrecise when you launch it.

(4) Click **Apply** to complete the setting.

Upon reaching the configured Platform Lock Timer threshold, the system initiates a secure lock state, requiring authentication for further access.

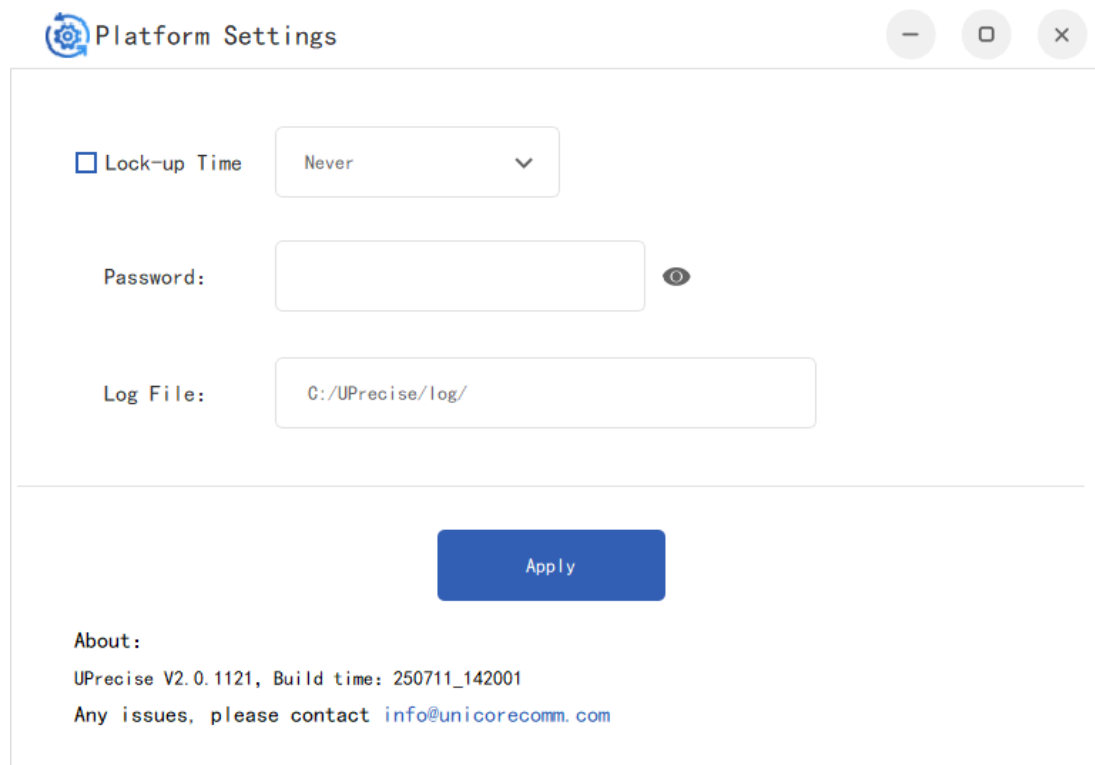

Figure3-37 platform-settings

## 3.16 Platform Lock

UPrecise supports the **Platform Lock** feature.

When the platform is locked, any operation to the software cannot be performed.

To use **Platform Lock**, follow the steps below:

1. Set a password first. See [Platform Settings](#).
2. Click the **Platform Lock** icon on the menu bar.

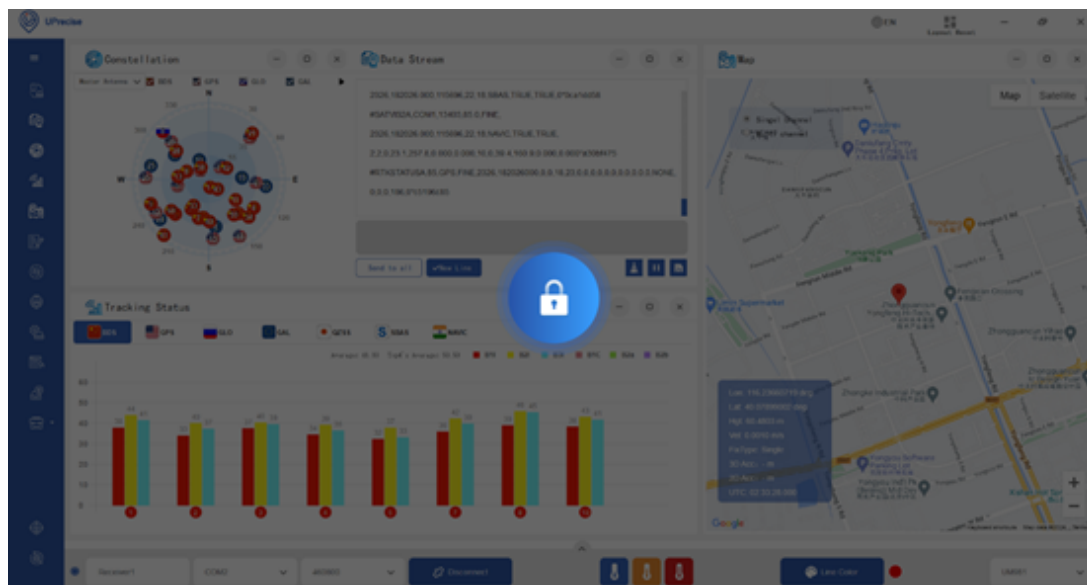

Figure3-38 Lock Button

3. To unlock UPrecise, click the **lock** icon in the middle of the screen and type in the password. Then UPrecise is operational and configurable again.

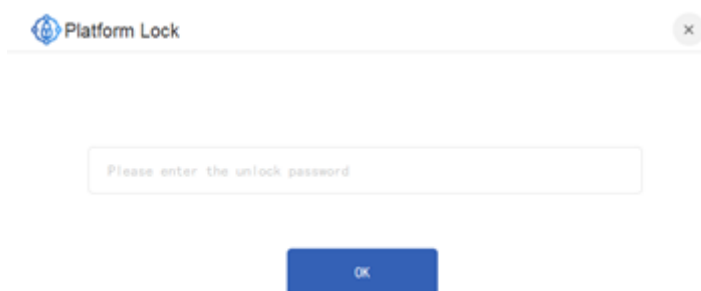

Figure3-39 Unlock

**和芯星通科技（北京）有限公司**

**Unicore Communications, Inc.**

北京市海淀区丰贤东路7号北斗星通大厦三层  
F3, No.7, Fengxian East Road, Haidian, Beijing, P.R.China,  
100094

[www.unicore.com](http://www.unicore.com)

Phone: 86-10-69939800

Fax: 86-10-69939888

[info@unicorecomm.com](mailto:info@unicorecomm.com)



[www.unicore.com](http://www.unicore.com)